

Vertical Tower Assembly That Attaches to the Sprayer Structural Frame

Smart  **Apply**[®]
Intelligent Spray Control System[™]



INSTALLATION INSTRUCTIONS

Vertical Tower Assembly That Attaches to the Sprayer Structural Frame

KK128484 ISSUE A5 (ENGLISH)

Precision Upgrades
North American Edition
PRINTED IN U.S.A.

Contents

	Page
Introduction	
Introduction	05-1
Compatibility Chart	05-1
Trademarks	05-1
Download Instructions	05-2
Safety	
Recognize Safety Information	10-1
Understand Signal Words	10-1
Follow Safety Instructions	10-1
Replace Safety Signs	10-2
Prepare for Emergencies	10-2
Wear Protective Clothing	10-2
Protect Against Noise	10-3
Practice Safe Maintenance	10-3
Park Machine Safely	10-4
Work in Clean Area	10-4
Avoid High-Pressure Fluids	10-4
Decontaminate Spray Equipment Before Servicing	10-5
Clean Vehicle of Hazardous Chemicals, Including Pesticides	10-5
Use Proper Tools	10-5
Work In Ventilated Area	10-6
Handling Batteries Safely	10-6
Support Machine Properly	10-7
Use Proper Lifting Equipment	10-7
Vertical Tower Assembly That Attaches to the Sprayer Structural Frame	
Bracket Frame Assembly	20-1
LiDAR Assembly	20-7
Air Blower Assembly	20-12
Air Filter Assembly	20-17
Controller Box Assembly	20-21
GPS Antenna Assembly	20-25
Brass Assembly	20-27
Nozzles Assembly	20-29
Solenoids Assembly	20-31
Harness Routing	20-33
Electrical Diagram	20-38
Liquid Filter Kit	20-39
Pressure Regulator Kit	20-40

Original Instructions. All information, illustrations and specifications in this manual are based on the latest information available at the time of publication. The right is reserved to make changes at any time without notice.

COPYRIGHT © 2025

Introduction

Introduction

IMPORTANT: Read this instruction thoroughly and familiarize yourself with the machine before performing the procedure. Do not skip steps or perform them out of order.

IMPORTANT: Stainless steel is a soft metal, use only hand tools or electric wrenches for tightening. Avoid using impact wrenches and prevailing torque fasteners to prevent damage.

This instruction demonstrates the proper procedure for installing the Smart Apply Intelligent Spray System onto the air blast sprayer.

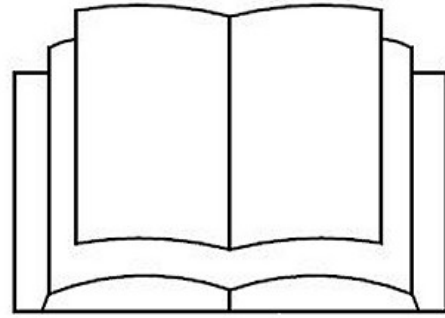

A95278—UN—23FEB17

HL70592,1732041102726-19-27JAN25-1/1

Compatibility Chart

IMPORTANT: Customers are advised to verify their model against the compatibility chart before proceeding with the installation.

To verify the compatibility of this kit with your machine, it is recommended to review the compatibility chart available on the Smart Apply™ website. This can be accessed using the QR Code provided below:



YK65311—UN—12NOV24

Access to compatibility chart on Smart Apply™ website

HL70592,1732040913987-19-27JAN25-1/1

Trademarks

Trademarks	
Smart Apply®	Registered trademark of Smart Apply
Teflon™	Teflon is a trademark of the Chemours Company

UE5VH6W,1735935358063-19-09JAN25-1/1

Download Instructions

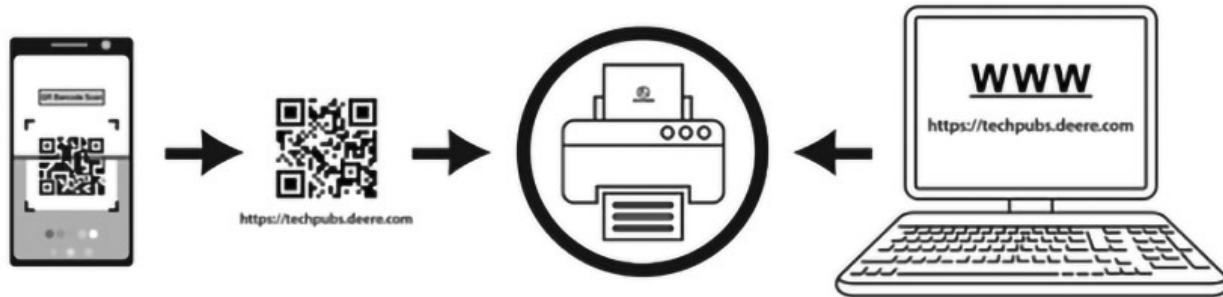

Instructions, manuals, and other documents may be downloaded at [www.techpubs.deere.com](https://techpubs.deere.com). Scanning the QR code on a mobile device will route to the site automatically.

Les instructions, les manuels et autres documents peuvent être téléchargés à cette adresse: [www.techpubs.deere.com](https://techpubs.deere.com). Scanner le QR code via un appareil mobile mène automatiquement au site.

Istruzioni, manuali e altri documenti possono essere scaricati su [www.techpubs.deere.com](https://techpubs.deere.com). La scansione del codice QR su un dispositivo portatile indirizza automaticamente al sito.

Anleitungen, Handbücher und andere Dokumente können unter [www.techpubs.deere.com](https://techpubs.deere.com) heruntergeladen werden. Durch Scannen des QR-Codes mit einem Mobilgerät wird man automatisch zur Webseite weitergeleitet.

Las instrucciones, los manuales y otros documentos se pueden descargar en [www.techpubs.deere.com](https://techpubs.deere.com). Al escanear el código QR en un dispositivo móvil, se abrirá automáticamente el sitio web.

Instruções, manuais e outros documentos podem ser baixados em [www.techpubs.deere.com](https://techpubs.deere.com). A leitura do código QR em um dispositivo móvel levará você automaticamente para o site.

Инструкции, руководства и другие документы можно загрузить на странице [www.techpubs.deere.com](https://techpubs.deere.com). Сканирование QR-кода на мобильном устройстве будет автоматически отправлять на сайт.

Safety

Recognize Safety Information

This is a safety-alert symbol. When you see this symbol on your machine or in this manual, be alert to the potential for personal injury.

Follow recommended precautions and safe operating practices.



T81389—UN—28JUN13

DX,ALERT-19-03OCT22-1/1

Understand Signal Words

DANGER; The signal word DANGER indicates a hazardous situation which, if not avoided, will result in death or serious injury.

WARNING; The signal word WARNING indicates a hazardous situation which, if not avoided, could result in death or serious injury.

CAUTION; The signal word CAUTION indicates a hazardous situation which, if not avoided, could result in minor or moderate injury. CAUTION may also be used to alert against unsafe practices associated with events which could lead to personal injury.

A signal word—DANGER, WARNING, or CAUTION—is used with the safety-alert symbol. DANGER identifies the most serious hazards. DANGER or WARNING safety signs



TS187—19—30SEP88

are located near specific hazards. General precautions are listed on CAUTION safety signs. CAUTION also calls attention to safety messages in this manual.

DX,SIGNAL-19-05OCT16-1/1

Follow Safety Instructions

Carefully read all safety messages in this instruction. Read the product operator's manual for operating instructions and safety messages.

Do not let anyone operate machine until they have been properly instructed.



TS201—UN—15APR13

HL70592,1732220639779-19-22NOV24-1/1

Replace Safety Signs

Replace missing or damaged safety signs. See the machine operator's manual for correct safety sign placement.



TS201—UN—15APR13

DX,SIGNS1-19-04JUN90-1/1

Prepare for Emergencies

Be prepared if a fire starts.

Keep a first aid kit and fire extinguisher handy.

Keep emergency numbers for doctors, ambulance service, hospital, and fire department near your telephone.

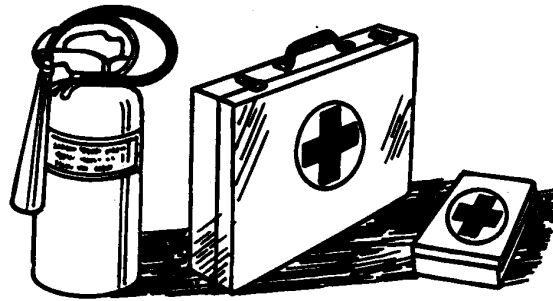

TS291—UN—15APR13

DX,FIRE2-19-03MAR93-1/1

Wear Protective Clothing

Wear close fitting clothing and safety equipment appropriate to the job.

Operating equipment safely requires the full attention of the operator. Do not wear radio or music headphones while operating machine.

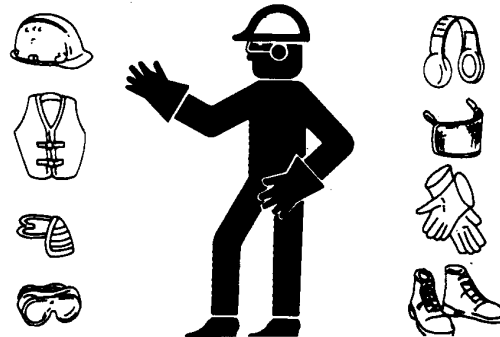

TS206—UN—15APR13

DX,WEAR2-19-03MAR93-1/1

Protect Against Noise

There are many variables that affect the sound level range, including machine configuration, condition and maintenance level of the machine, ground surface, operating environmental, duty cycles, ambient noise, and attachments.

Exposure to loud noise can cause impairment or loss of hearing.

Always wear hearing protection. Wear a suitable hearing protective device such as earmuffs or earplugs to protect against objectionable or uncomfortable loud noises.



TS207—UN—23AUG88

DX,NOISE-19-03OCT17-1/1

Practice Safe Maintenance

Understand service procedure before doing work. Keep area clean and dry.

Never lubricate, service, or adjust machine while it is moving. Keep hands, feet, and clothing away from power-driven parts. Disengage all power and operate controls to relieve pressure. Lower equipment to the ground. Stop the engine. Remove the key. Allow machine to cool.

Securely support any machine elements that must be raised for service work.

Keep all parts in good condition and properly installed. Fix damage immediately. Replace worn or broken parts. Remove any buildup of grease, oil, or debris.

On self-propelled equipment, disconnect battery ground cable (-) before making adjustments on electrical systems or welding on machine.

On towed implements, disconnect wiring harnesses from tractor before servicing electrical system components or welding on machine.

Falling while cleaning or working at height can cause serious injury. Use a ladder or platform to easily reach each location. Use sturdy and secure footholds and handholds.



TS218—UN—23AUG88

DX,SERV-19-28FEB17-1/1

Park Machine Safely

Before working on the machine:

- Lower all equipment to the ground.
- Stop the engine and remove the key.
- Disconnect the battery ground strap.
- Hang a "DO NOT OPERATE" tag in operator station.

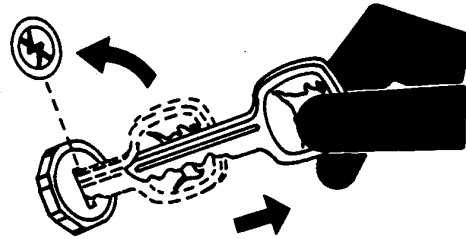

TS230—UN—24MAY89

DX,PARK-19-04JUN90-1/1

Work in Clean Area

Before starting a job:

- Clean work area and machine.
- Make sure you have all necessary tools to do your job.
- Have the right parts on hand.
- Read all instructions thoroughly; do not attempt shortcuts.

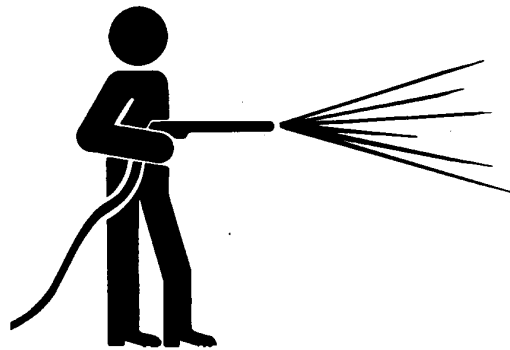

T6642EJ—UN—18OCT88

DX,CLEAN-19-04JUN90-1/1

Avoid High-Pressure Fluids

Inspect hydraulic hoses periodically – at least once per year – for leakage, kinking, cuts, cracks, abrasion, blisters, corrosion, exposed wire braid or any other signs of wear or damage.

Replace worn or damaged hose assemblies immediately with approved replacement parts.

Escaping fluid under pressure can penetrate the skin causing serious injury.

Avoid the hazard by relieving pressure before disconnecting hydraulic or other lines. Tighten all connections before applying pressure.

Search for leaks with a piece of cardboard. Protect hands and body from high-pressure fluids.

If an accident occurs, see a doctor immediately. Any fluid

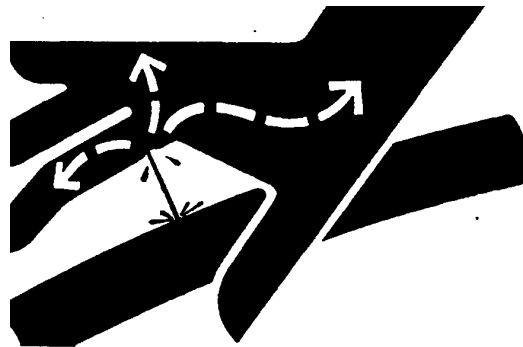

X9811—UN—23AUG88

injected into the skin must be surgically removed within a few hours or gangrene may result. Doctors unfamiliar with this type of injury should reference a knowledgeable medical source.

HL70592,1732220733323-19-22NOV24-1/1

Decontaminate Spray Equipment Before Servicing

⚠ CAUTION: Spray solutions or vapors can be extremely dangerous. Treat all spray chemicals, solutions, and solution residues with great caution. **DO NOT** take chances. When in doubt, proceed as though contamination is present.

Before performing any service activity:

- Wear appropriate personal protective equipment.

- Clean vehicle (see Clean Vehicle of Hazardous Chemicals, Including Pesticides in this section).
- Drain Solution Tank (see machine operator's manual).
- Rinse wet system (see operator's manual).

Keep spray material from contacting skin. If spray material contacts skin, wash off immediately with clean water and detergent, or follow manufacturers instructions for chemical used last.

Wear protective clothing, goggles, and gloves while attaching parts.

LD45720,0000462-19-24JAN18-1/1

Clean Vehicle of Hazardous Chemicals, Including Pesticides

⚠ CAUTION: During application of hazardous chemicals, including pesticides, residue can build up on the inside or outside of the vehicle. Clean vehicle according to use instructions of hazardous chemical.

When exposed to hazardous chemicals, clean exterior and interior of vehicle daily to keep free of the accumulation of visible dirt and contamination.

1. Sweep or vacuum the floor of cab.
2. Clean headliners and inside cowlings of cab.

IMPORTANT: Directing pressurized water at electronic/electrical components or connectors, bearings and hydraulic seals, fuel injection pumps or other sensitive parts and components may cause product malfunctions. Reduce pressure, and spray at a 45 to 90 degree angle.

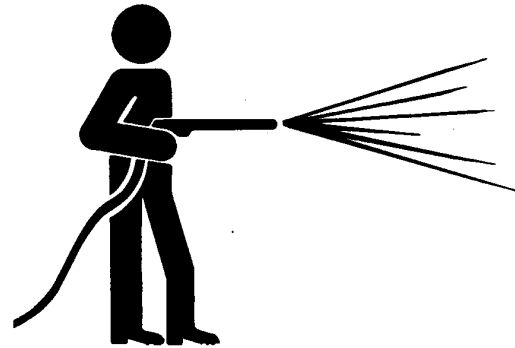

T6642EJ—UN—18OCT88

3. Wash entire exterior of vehicle.
4. Dispose of any wash water with hazardous concentrations of active or non-active ingredients according to published regulations or directives.

OOU6092,000081B-19-18JAN21-1/1

Use Proper Tools

Use tools appropriate to the work. Makeshift tools and procedures can create safety hazards.

Use power tools only to loosen threaded parts and fasteners.

For loosening and tightening hardware, use the correct size tools. **DO NOT** use U.S. measurement tools on metric fasteners. Avoid bodily injury caused by slipping wrenches.

Use only approved service parts.



TS779—UN—08NOV89

UE5VH6W,1736448119093-19-09JAN25-1/1

Work In Ventilated Area

Engine exhaust fumes can cause sickness or death. If it is necessary to run an engine in an enclosed area, remove the exhaust fumes from the area with an exhaust pipe extension.

If you do not have an exhaust pipe extension, open the doors and get outside air into the area.

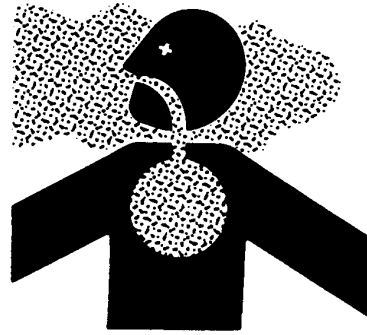

TS220—UN—15APR13

DX,AIR-19-17FEB99-1/1

Handling Batteries Safely

Battery gas can explode. Keep sparks and flames away from batteries. Use a flashlight to check battery electrolyte level.

Never check battery charge by placing a metal object across the posts. Use a voltmeter or hydrometer.

Always remove grounded (-) battery clamp first and replace grounded clamp last.

Sulfuric acid in battery electrolyte is poisonous and strong enough to burn skin, eat holes in clothing, and cause blindness if splashed into eyes.

Avoid hazards by:

- Filling batteries in a well-ventilated area
- Wearing eye protection and rubber gloves
- Avoiding use of air pressure to clean batteries
- Avoiding breathing fumes when electrolyte is added
- Avoiding spilling or dripping electrolyte
- Using correct battery booster or charger procedure.

If acid is spilled on skin or in eyes:

1. Flush skin with water.
2. Apply baking soda or lime to help neutralize the acid.
3. Flush eyes with water for 15—30 minutes. Get medical attention immediately.

If acid is swallowed:

1. Do not induce vomiting.
2. Drink large amounts of water or milk, but do not exceed 2 L (2 qt.).
3. Get medical attention immediately.

WARNING: Battery posts, terminals, and related accessories contain lead and lead compounds, chemicals known to the State of California to cause cancer and reproductive harm. **Wash hands after handling.**



TS204—UN—15APR13

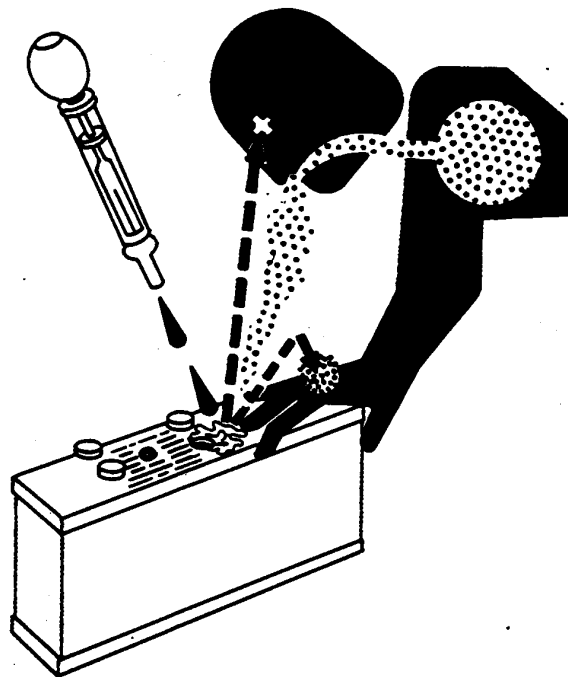

TS203—UN—23AUG88

DX,WW,BATTERIES-19-02DEC10-1/1

Support Machine Properly

Always lower the attachment or implement to the ground before you work on the machine. If the work requires that the machine or attachment be lifted, provide secure support for them. If left in a raised position, hydraulically supported devices can settle or leak down.

Do not support the machine on cinder blocks, hollow tiles, or props that may crumble under continuous load. Do not work under a machine that is supported solely by a jack. Follow recommended procedures in this manual.

When implements or attachments are used with a machine, always follow safety precautions listed in the implement or attachment operator's manual.

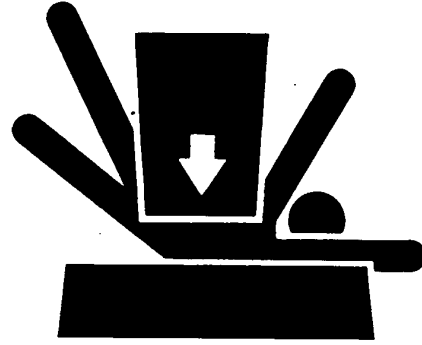

TS229—UN—23AUG88

DX,LOWER-19-24FEB00-1/1

Use Proper Lifting Equipment

Lifting heavy components incorrectly can cause severe injury or machine damage.

Follow recommended procedure for removal and installation of components in the manual.

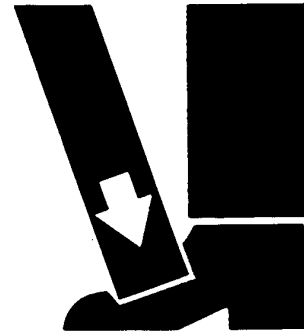

TS226—UN—23AUG88

DX,LIFT-19-20DEC24-1/1

Vertical Tower Assembly That Attaches to the Sprayer Structural Frame

Bracket Frame Assembly

Step 1 of 6: Bracket assembly

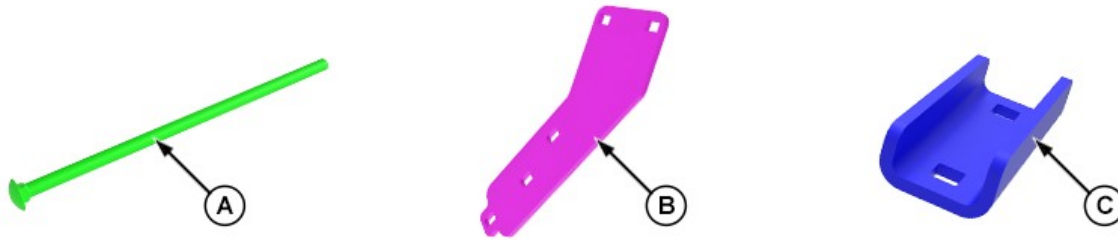

YK133454—UN—08NOV24

Parts required for this step			
Identifier	Part Number	Description	Quantity
A	7100522	Bolt	8
B	1100324	Bracket	2
C	1100325	Clamp bracket	2

1. Insert 4 bolts (A) into the last slots of bracket (B) and the clamp bracket (C) between the two bolts at the front.

NOTE: Repeat this step two times, for left and right-hand sides.

WVFXMED,1730130578140-19-28JAN25-1/12

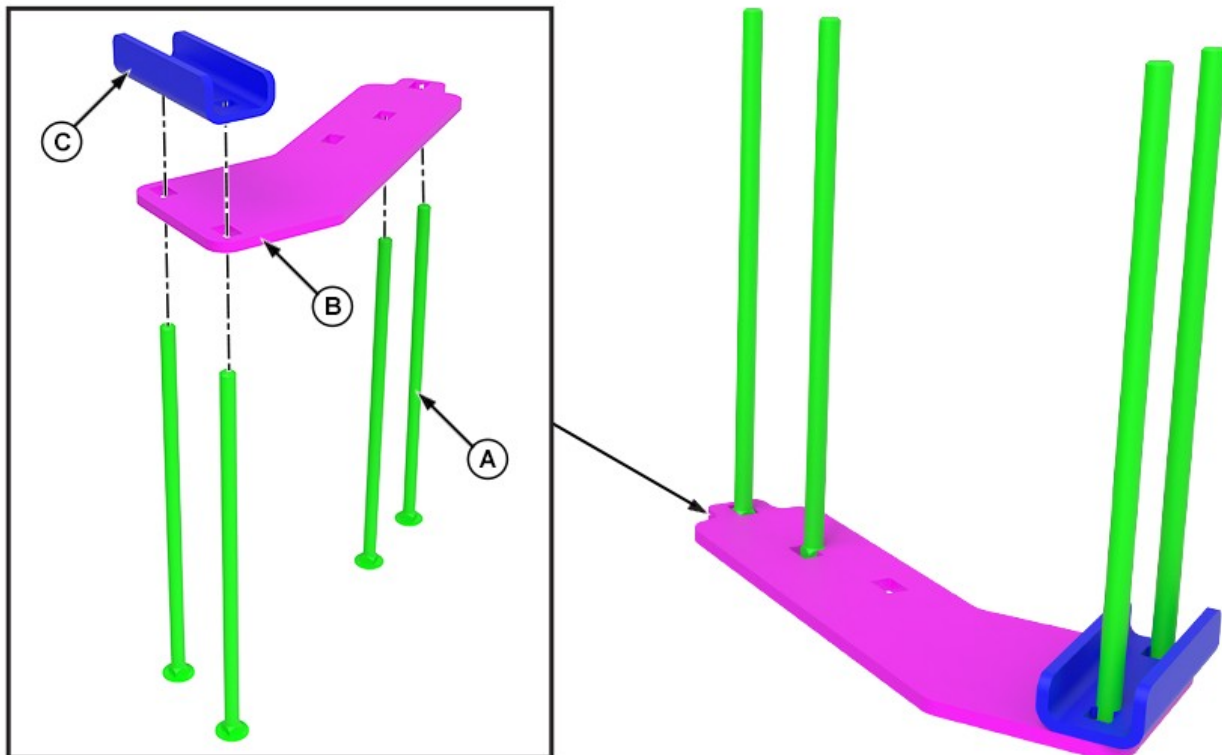

YK133455—UN—08NOV24

Continued on next page

WVFXMED,1730130578140-19-28JAN25-2/12

Step 2 of 6: Bracket assembly

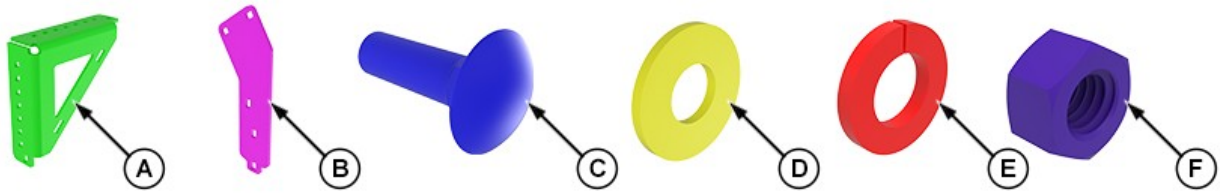

YK133456—UN—08NOV24

Parts required for this step

Identifier	Part Number	Description	Quantity
A	1100289	Corner bracket	2
B	1100324	Bracket	2
C	7100463	Bolt	2
D	7100460	Washer	2
E	7100520	Split washer	2
F	7100521	Nut	2

1. Assemble corner bracket (A) and bracket (B) using bolt (C), washer (D), split washer (E) and nut (F).

NOTE: Repeat this step two times, for left and right-hand sides.

WVFXMED,1730130578140-19-28JAN25-3/12

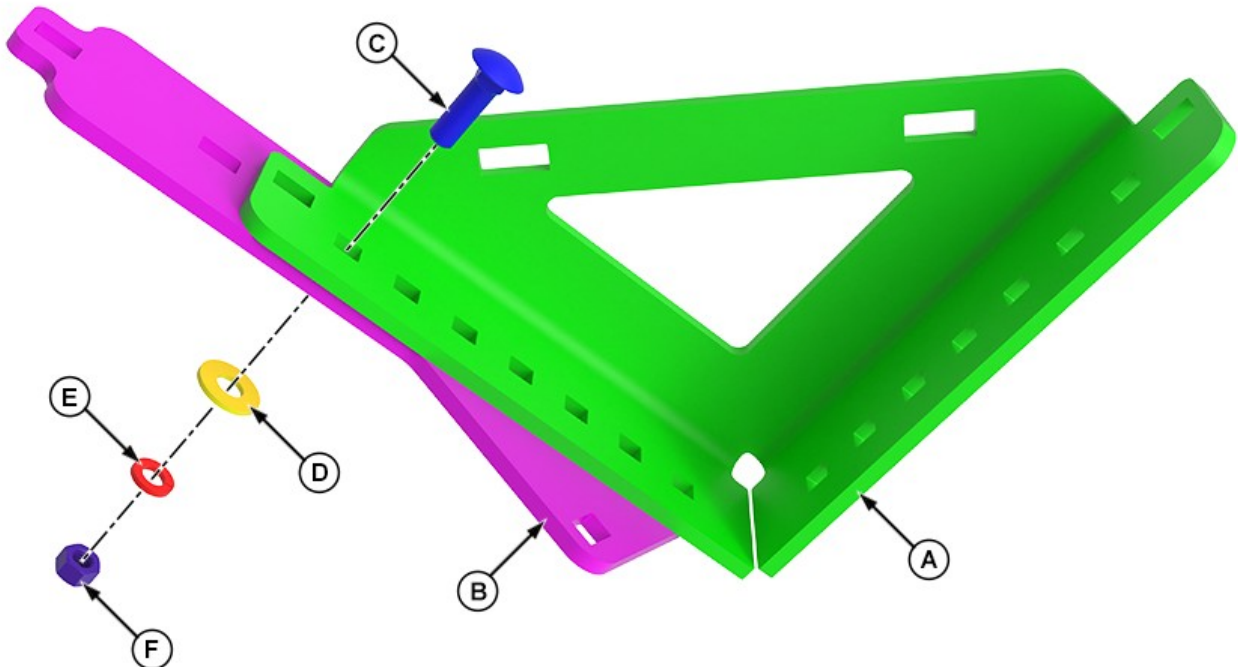

YK133457—UN—08NOV24

Continued on next page

WVFXMED,1730130578140-19-28JAN25-4/12

Step 3 of 6: Bracket mounting to machine

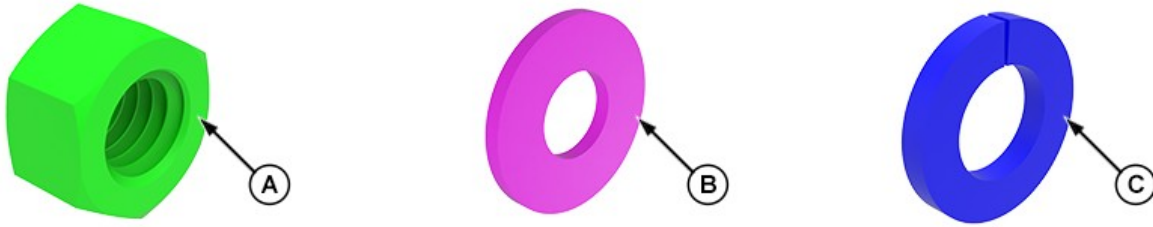

YK133458—UN—08NOV24

Parts required for this step

Identifier	Part Number	Description	Quantity
A	7100521	Nut	8
B	7100460	Washer	8
C	7100520	Split washer	8

1. Mount the previous assemblies around the sprayer RH side and LH side of frame. Position bolts fixing the frame and secure using nuts (A), washers (B), and split washers (C).

WVFXMED,1730130578140-19-28JAN25-5/12

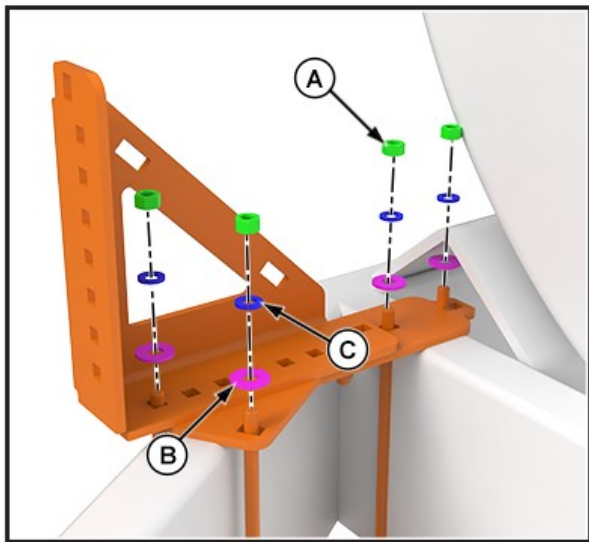

YK133459—UN—08NOV24

Continued on next page

WVFXMED,1730130578140-19-28JAN25-6/12

Step 4 of 6: Channel brackets installation

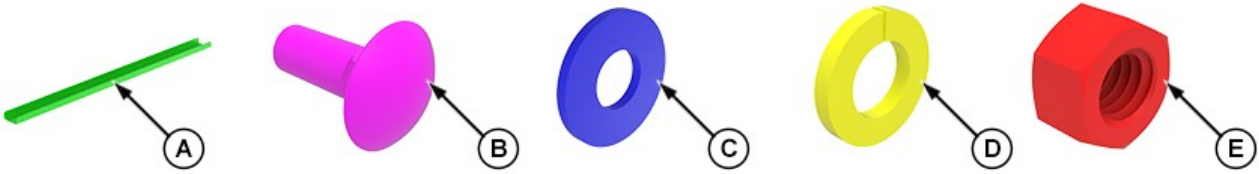

YK133460—UN—08NOV24

Parts required for this step

Identifier	Part Number	Description	Quantity
A	1100266	Channel bracket	2
B	7100462	Bolt	4
C	7100460	Washer	4
D	7100520	Split washer	4
E	7100521	Nut	4

1. Position channel bracket (A) inside LH and RH corner brackets and align the slots from the bottom and secure using bolts (B), washers (C), split washers (D), and nuts (E).

WVFXMED,1730130578140-19-28JAN25-7/12

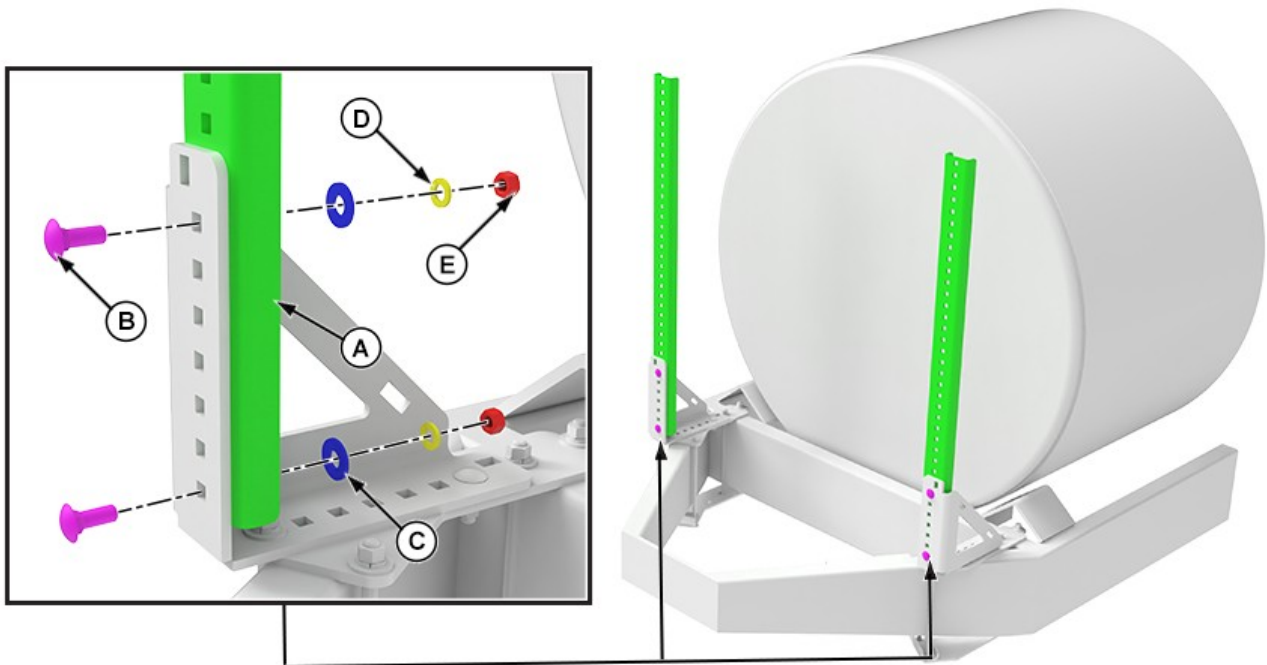

YK133461—UN—08NOV24

Continued on next page

WVFXMED,1730130578140-19-28JAN25-8/12

Step 5 of 6: Brackets installation

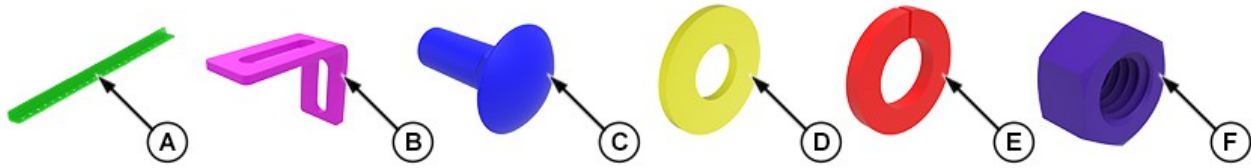

YK133462—UN—08NOV24

Parts required for this step

Identifier	Part Number	Description	Quantity
A	1100278	Bracket	2
B	1100268	Bracket	2
C	7100462	Bolt	6
D	7100460	Washer	6
E	7100520	Split washer	6
F	7100521	Nut	6

1. Install brackets (A) and (B) to LH and RH sides brackets using bolts (C), washers (D), split washers (E) and nuts (F).

WVFXMED,1730130578140-19-28JAN25-9/12

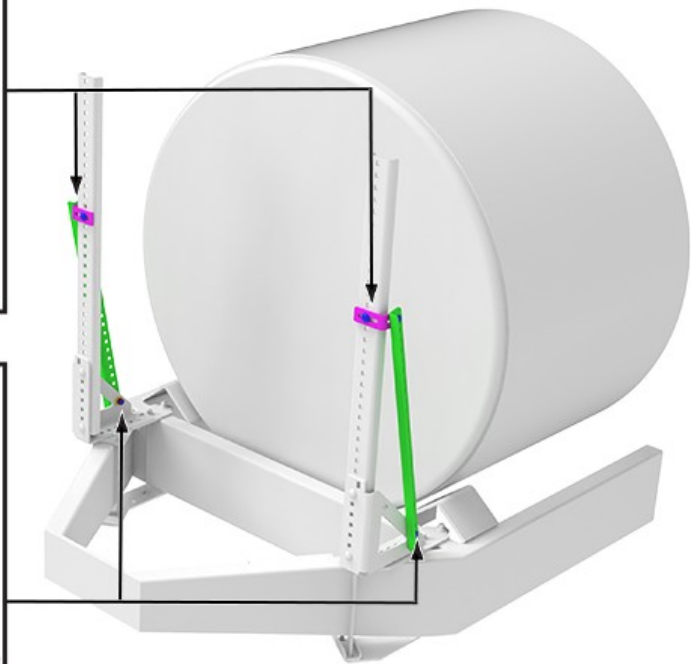
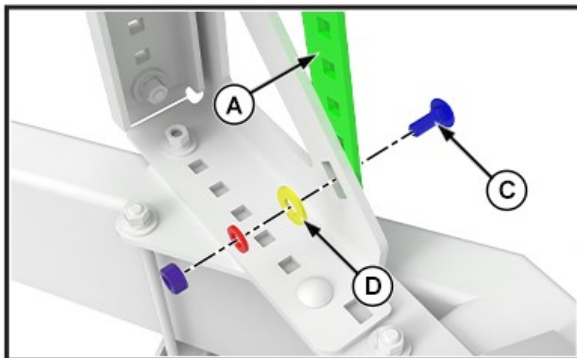
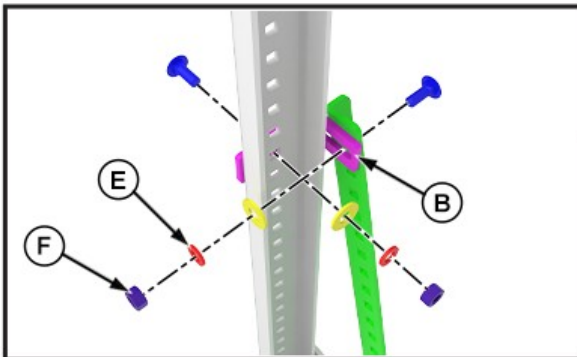

YK133463—UN—08NOV24

Continued on next page

WVFXMED,1730130578140-19-28JAN25-10/12

Step 6 of 6: Brackets installation

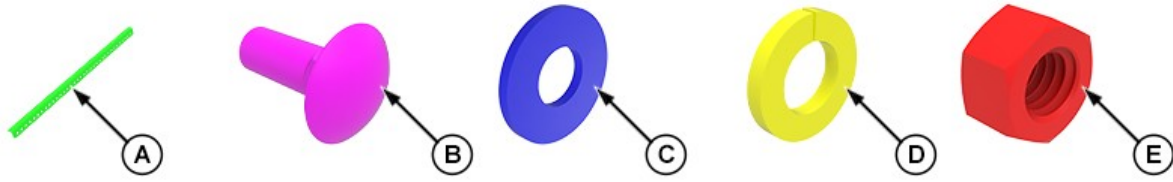

YK133464-UN-08NOV24

Parts required for this step

Identifier	Part Number	Description	Quantity
A	1100323	Bracket	2
B	7100462	Bolt	4
C	7100460	Washer	4
D	7100520	Split washer	4
E	7100521	Nut	4

1. Install brackets (A) centered with a gap of 7 slots between them and secure using bolts (B), washers (C), split washers (D), and nuts (E).

NOTE: To ensure the LIDAR is raised between 30 and 40 inches from the ground in the next steps, the upper bracket should also be positioned at the same height. Do not exceed 60 inches; if it goes beyond that height, it will not be able to detect objects 5 ft to the left or right.

WVFXMED,1730130578140-19-28JAN25-11/12

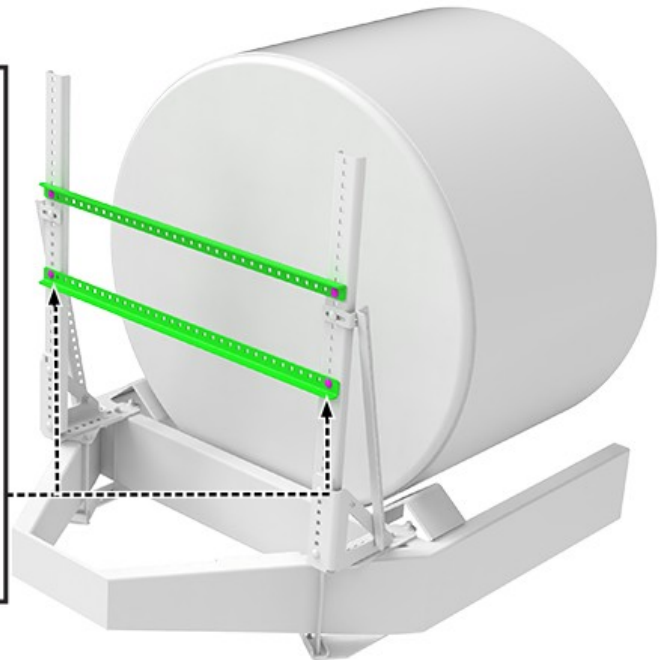
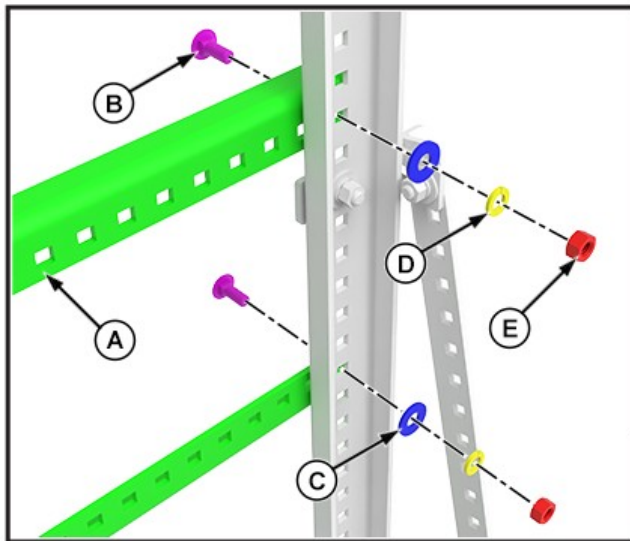

YK133465-UN-08NOV24

WVFXMED,1730130578140-19-28JAN25-12/12

LiDAR Assembly

Step 1 of 5: LiDAR assembly



YK133466-UN-08NOV24

Parts required for this step

Identifier	Part Number	Description	Quantity
A	1000040	LiDAR	1
B	1100354	LiDAR extension	1
C	7100509	Clamp	1

1. Assemble LiDAR (A) with LiDAR extension (B) and secure it with clamp (C).

IMPORTANT: To ensure performance of the LiDAR, it is crucial that there are no obstructions or moving objects within its vision range.

WVFXMED,1730130619336-19-16JAN25-1/10

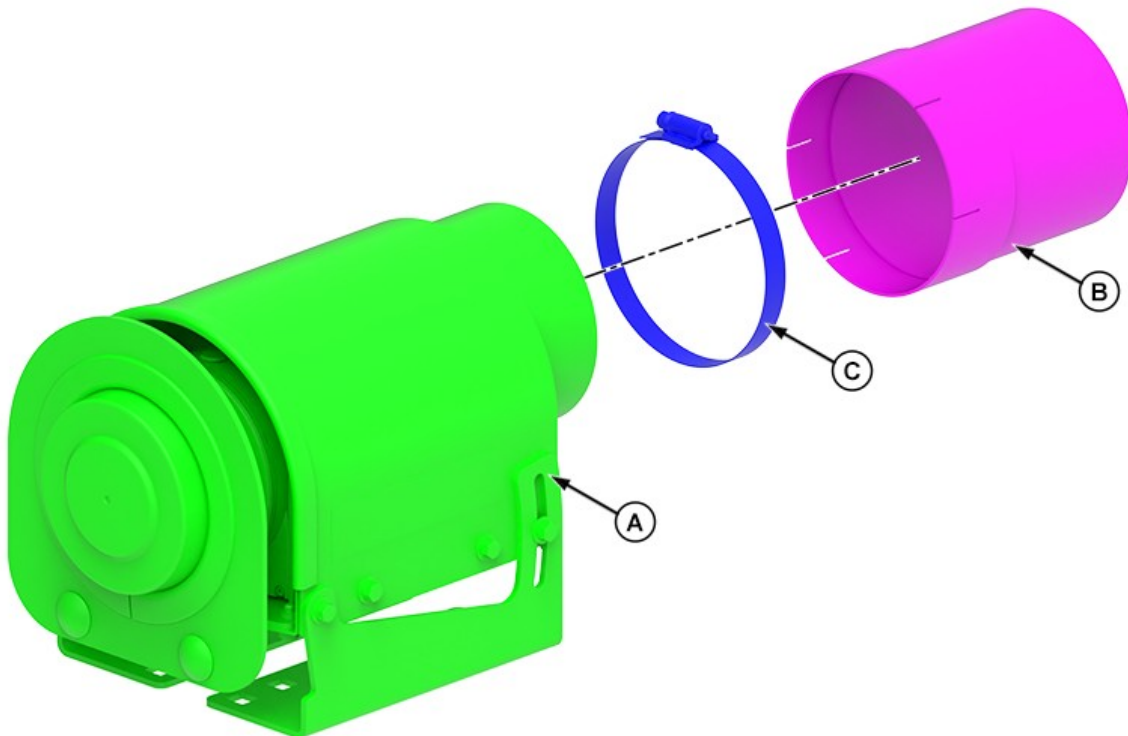

YK133467-UN-08NOV24

Continued on next page

WVFXMED,1730130619336-19-16JAN25-2/10

YK133243—UN—24OCT24

Step 2 of 5: Brackets installation

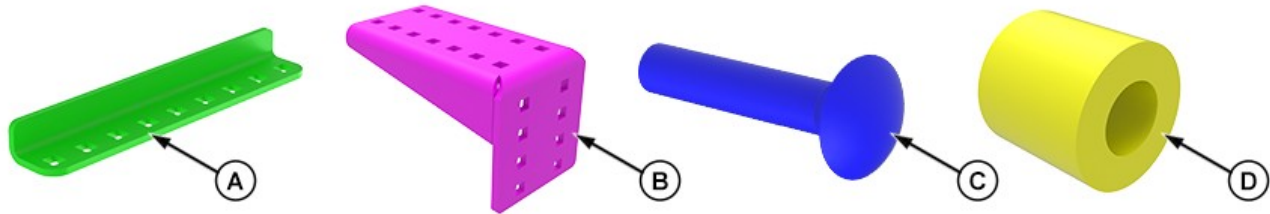

Parts required for this step

Identifier	Part Number	Description	Quantity
A	1100318	Bracket	2
B	1100355	Support	1
C	7100464	Bolt	4
D	1100267	Spacer	4

1. Install brackets (A) and support (B) centered onto existing bracket frame using bolts (C) and spacers (D).

WVFXMED,1730130619336-19-16JAN25-3/10

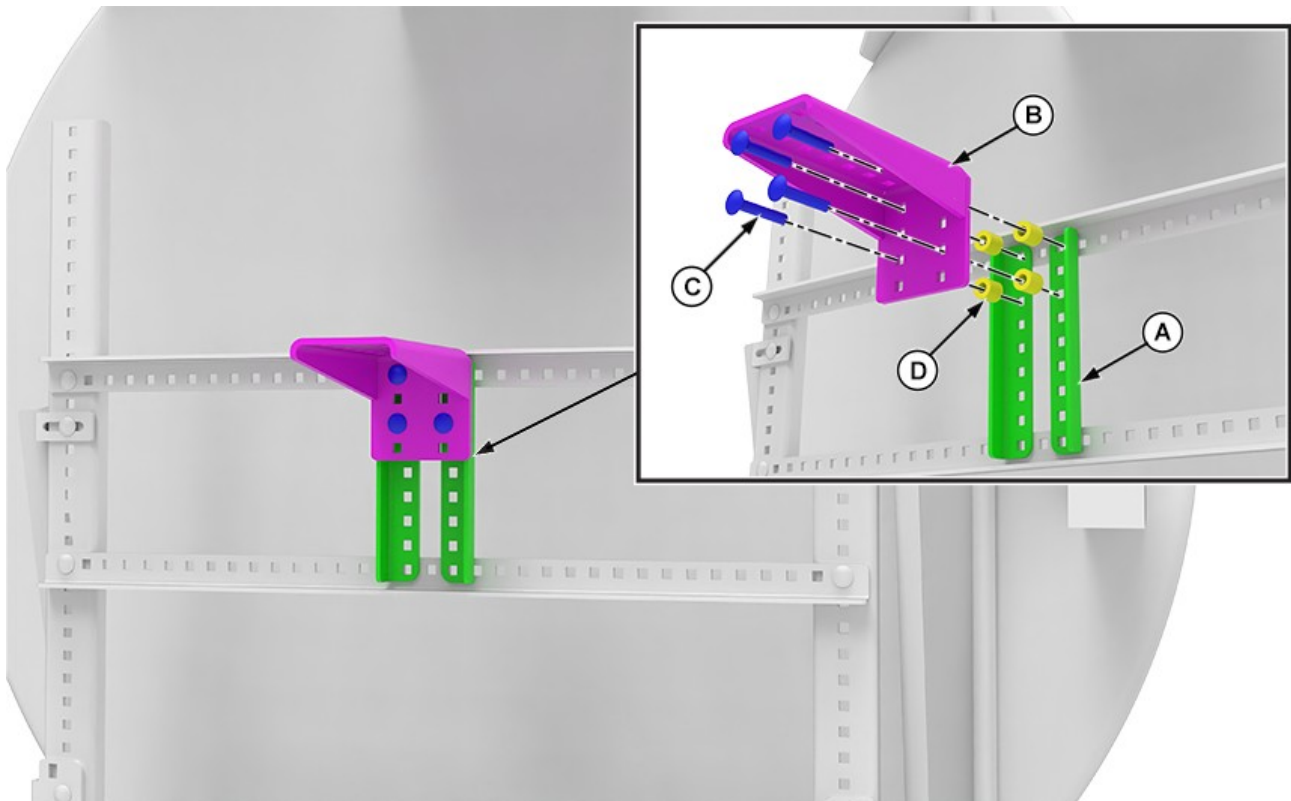

YK133244—UN—24OCT24

Continued on next page

WVFXMED,1730130619336-19-16JAN25-4/10

Step 3 of 5: Support installation

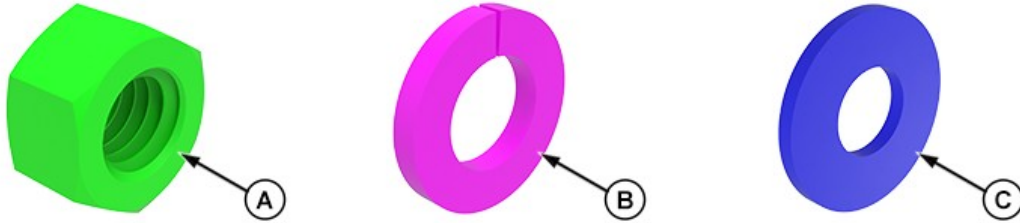

YK133245—UN—24OCT24

Parts required for this step

Identifier	Part Number	Description	Quantity
A	7100521	Nut	4
B	7100520	Split washer	4
C	7100460	Washer	4

1. Secure previously installed support and brackets to existing bracket frame using nuts (A), split washers (B) and washers (C).

WVFXMED.1730130619336-19-16JAN25-5/10

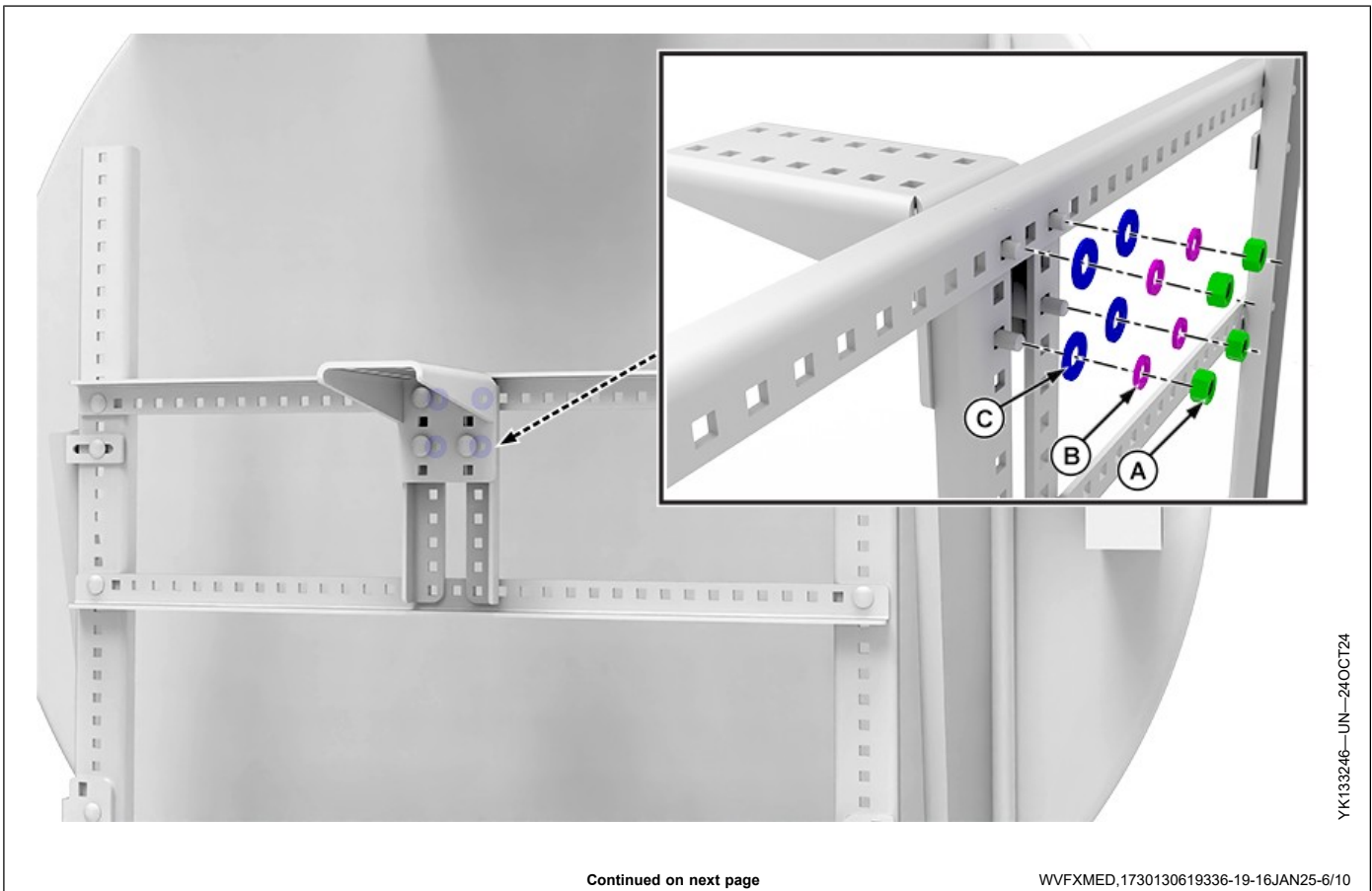

YK133246—UN—24OCT24

Continued on next page

WVFXMED.1730130619336-19-16JAN25-6/10

Step 4 of 5: Brackets installation

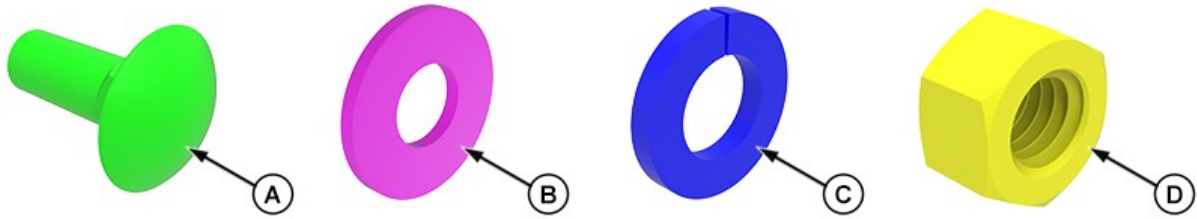

YK133247—UN—24OCT24

Parts required for this step

Identifier	Part Number	Description	Quantity
A	7100464	Bolt	2
B	7100460	Washer	2
C	7100520	Split washer	2
D	7100521	Nut	2

1. Secure previously installed brackets to existing bracket frame using bolts (A) washers (B), split washers (C) and nuts (D).

WVFXMED,1730130619336-19-16JAN25-7/10

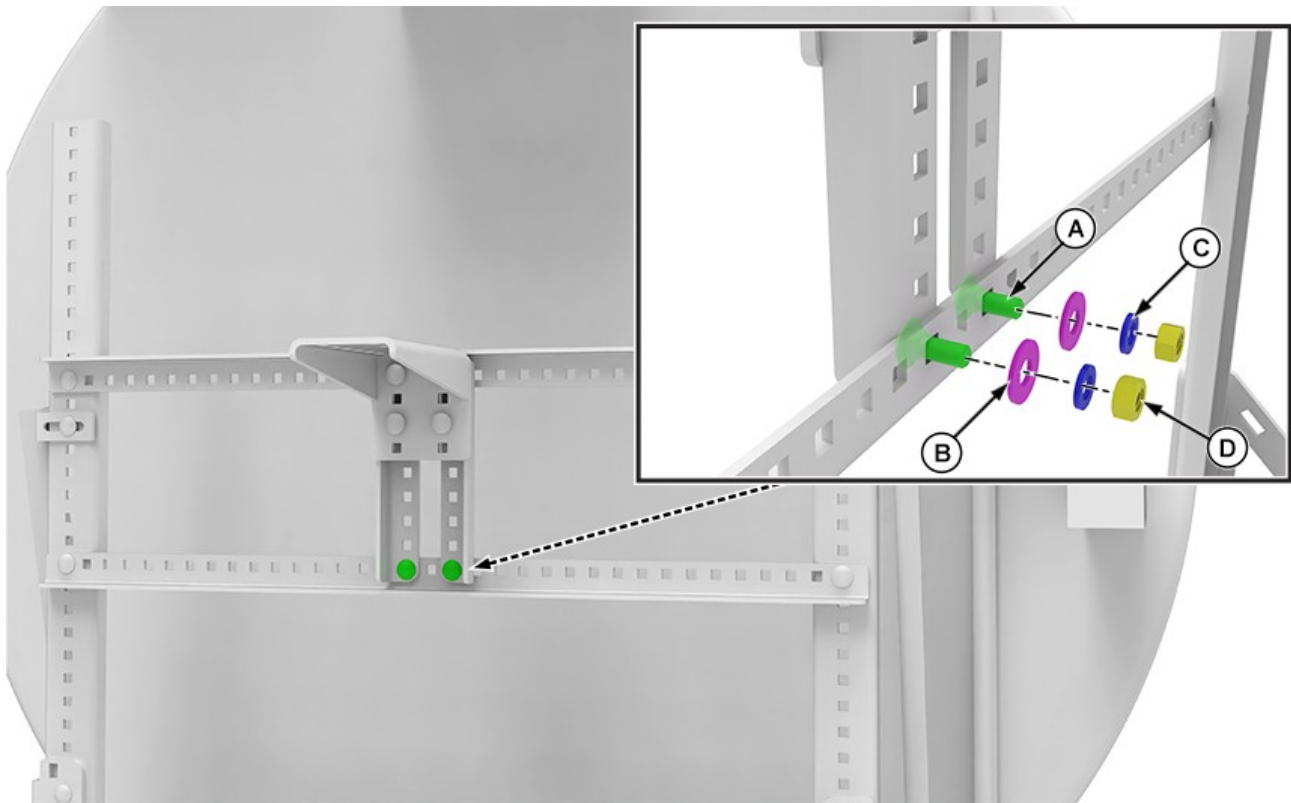

YK133248—UN—24OCT24

Continued on next page

WVFXMED,1730130619336-19-16JAN25-8/10

Step 5 of 5: LiDAR assembly installation

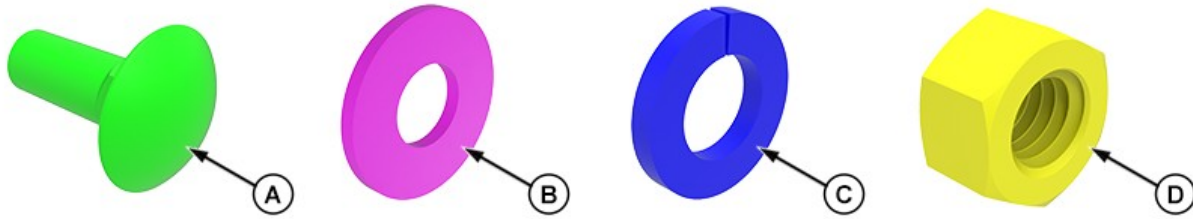

YK133247—UN—24OCT24

Parts required for this step

Identifier	Part Number	Description	Quantity
A	7100462	Bolt	4
B	7100460	Washer	4
C	7100520	Split washer	4
D	7100521	Nut	4

1. Install LiDAR assembly to support using bolts (A) washers (B), split washers (C) and nuts (D).

WVFXMED,1730130619336-19-16JAN25-9/10

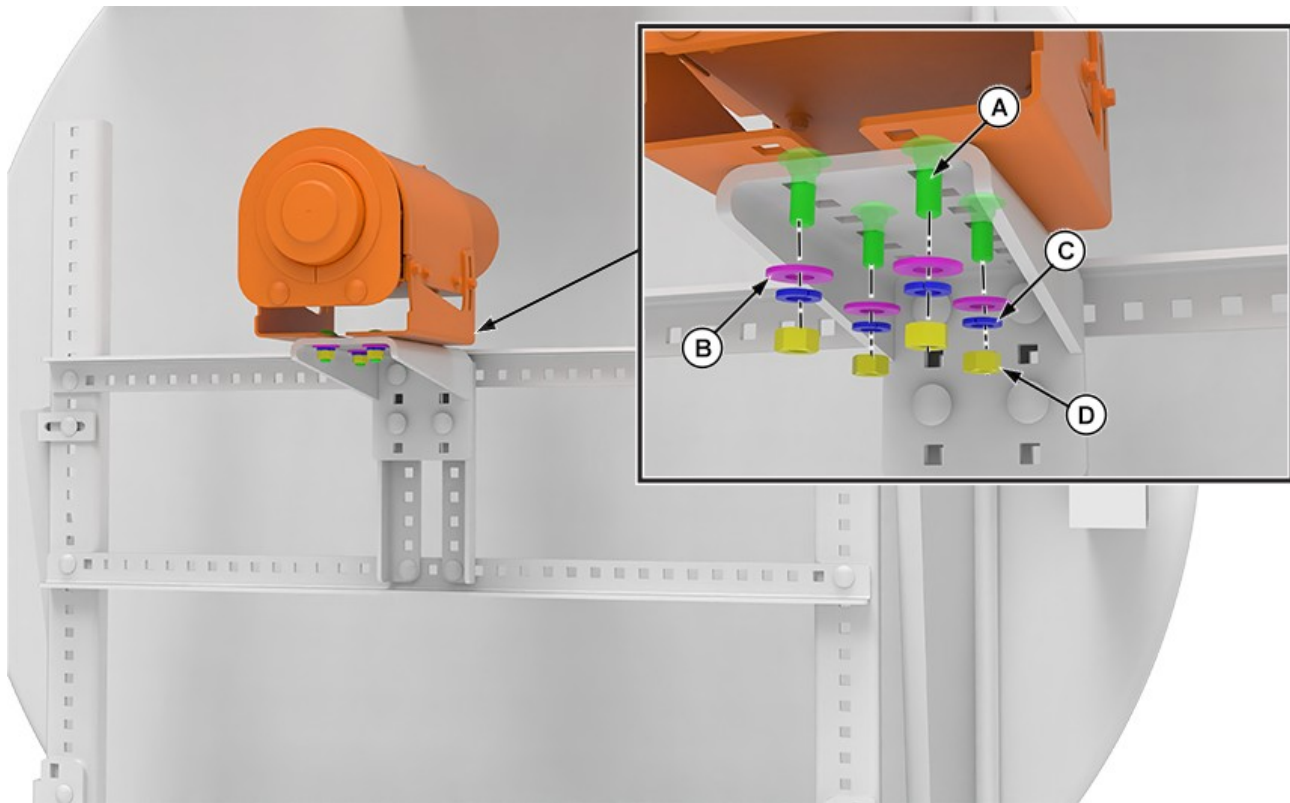

YK133249—UN—24OCT24

WVFXMED,1730130619336-19-16JAN25-10/10

Air Blower Assembly

Step 1 of 5: Brackets installation

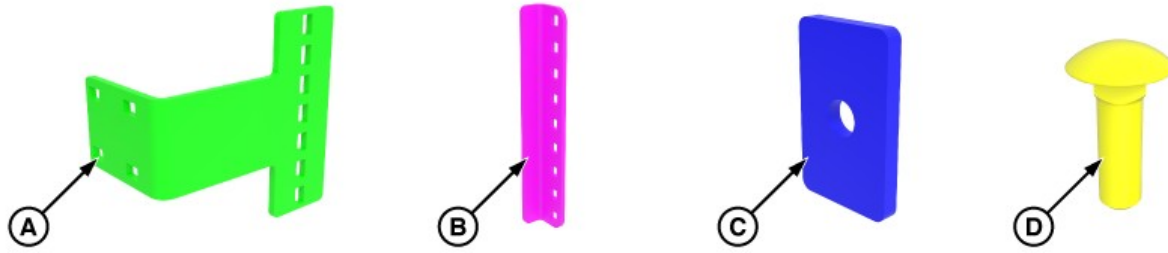

YK133468—UN—12NOV24

Parts required for this step			
Identifier	Part Number	Description	Quantity
A	1100347	Bracket	1
B	1100318	Bracket	2
C	1100319	Spacer	2
D	7100462	Bolt	6

1. Install bracket (A) with brackets (B) and spacers (C) using bolts (D) onto existing horizontal brackets.

WVFXMED,1730130661570-19-28JAN25-1/10

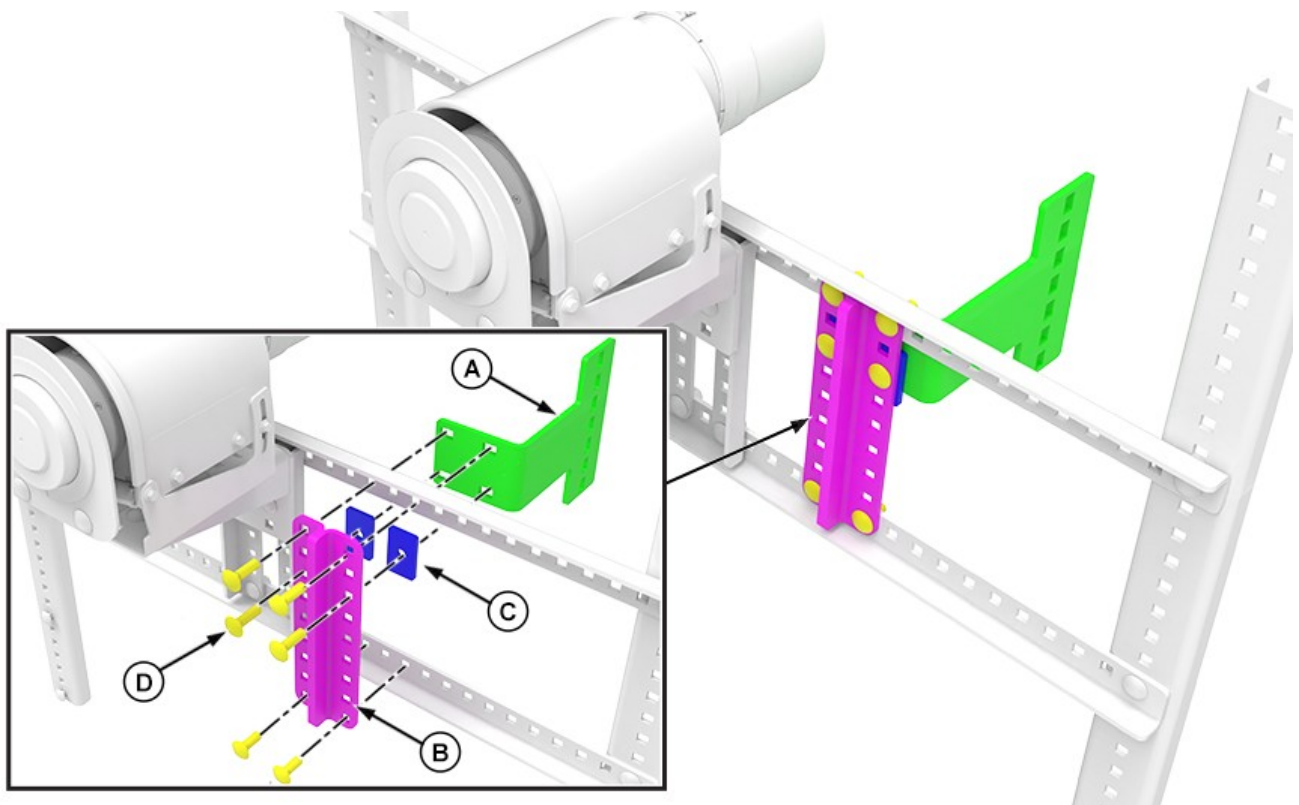

YK133469—UN—08JAN25

Continued on next page

WVFXMED,1730130661570-19-28JAN25-2/10

Step 2 of 5: Brackets installation

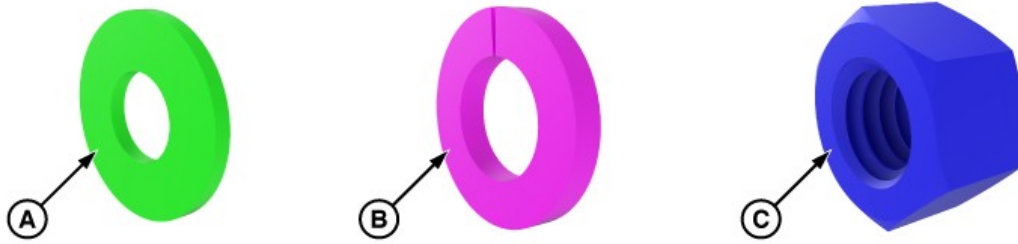

YK133470—UN—12NOV24

Parts required for this step

Identifier	Part Number	Description	Quantity
A	7100460	Washer	4
B	7100520	Split washer	4
C	7100521	Nut	4

1. Secure bracket assembly onto existing horizontal brackets frame using washers (A), split washers (B) and nuts (C).

WVFXMED,1730130661570-19-28JAN25-3/10

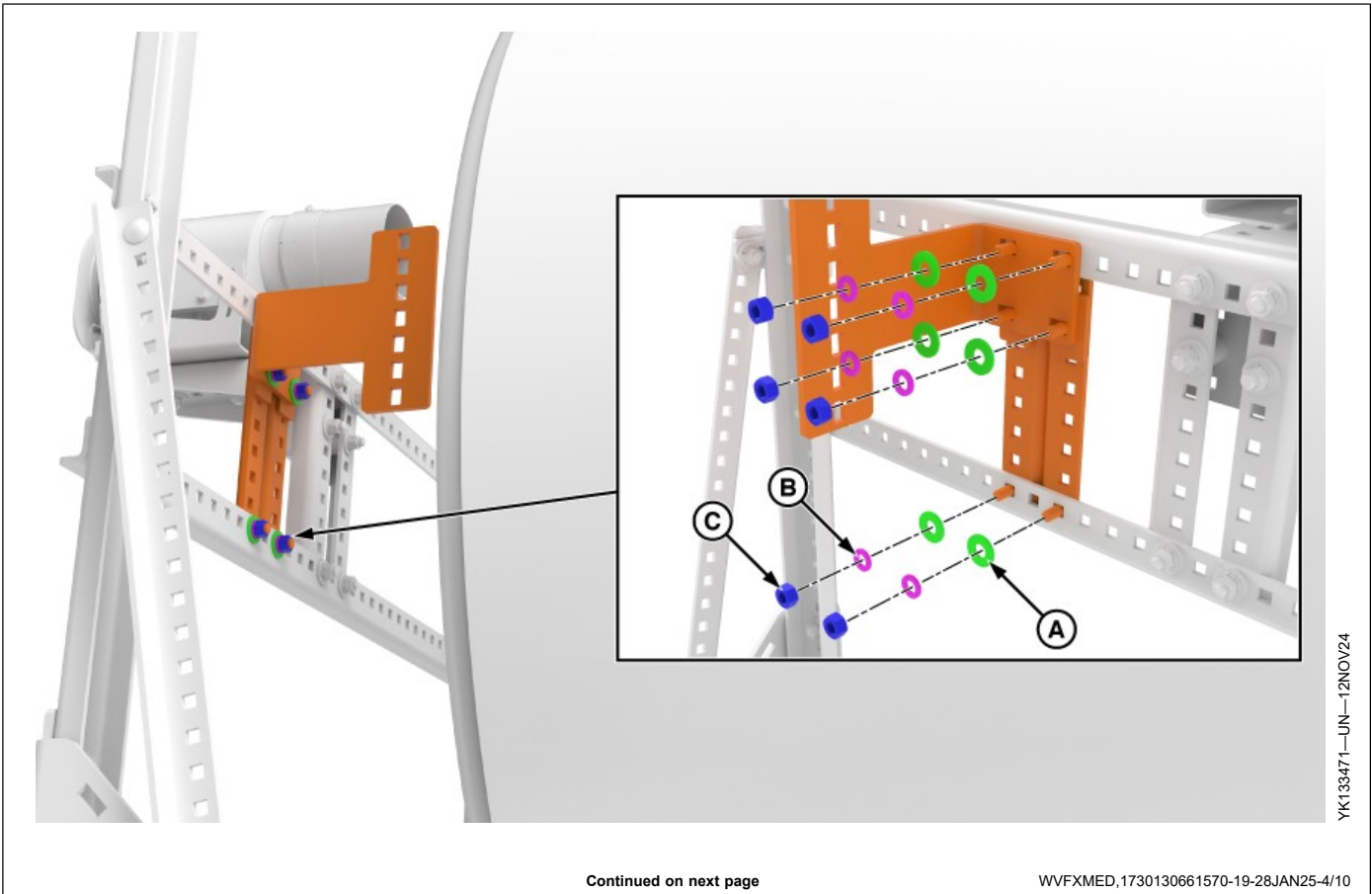

YK133471—UN—12NOV24

Continued on next page

WVFXMED,1730130661570-19-28JAN25-4/10

Step 3 of 5: Bracket installation

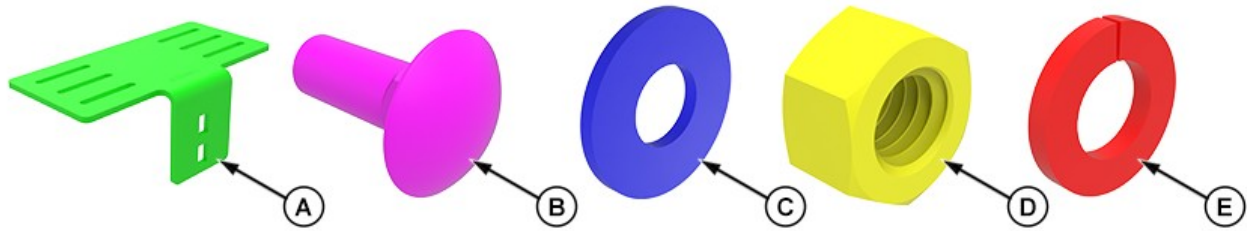

YK133264—UN—24OCT24

Parts required for this step

Identifier	Part Number	Description	Quantity
A	1100353	Bracket	1
B	7100462	Bolt	2
C	7100460	Washer	2
D	7100521	Nut	2
E	7100520	Split washer	2

1. Install bracket (A) to previously installed bracket using bolts (B), washers (C), nuts (D) and split washers (E).

WVFXMED,1730130661570-19-28JAN25-5/10

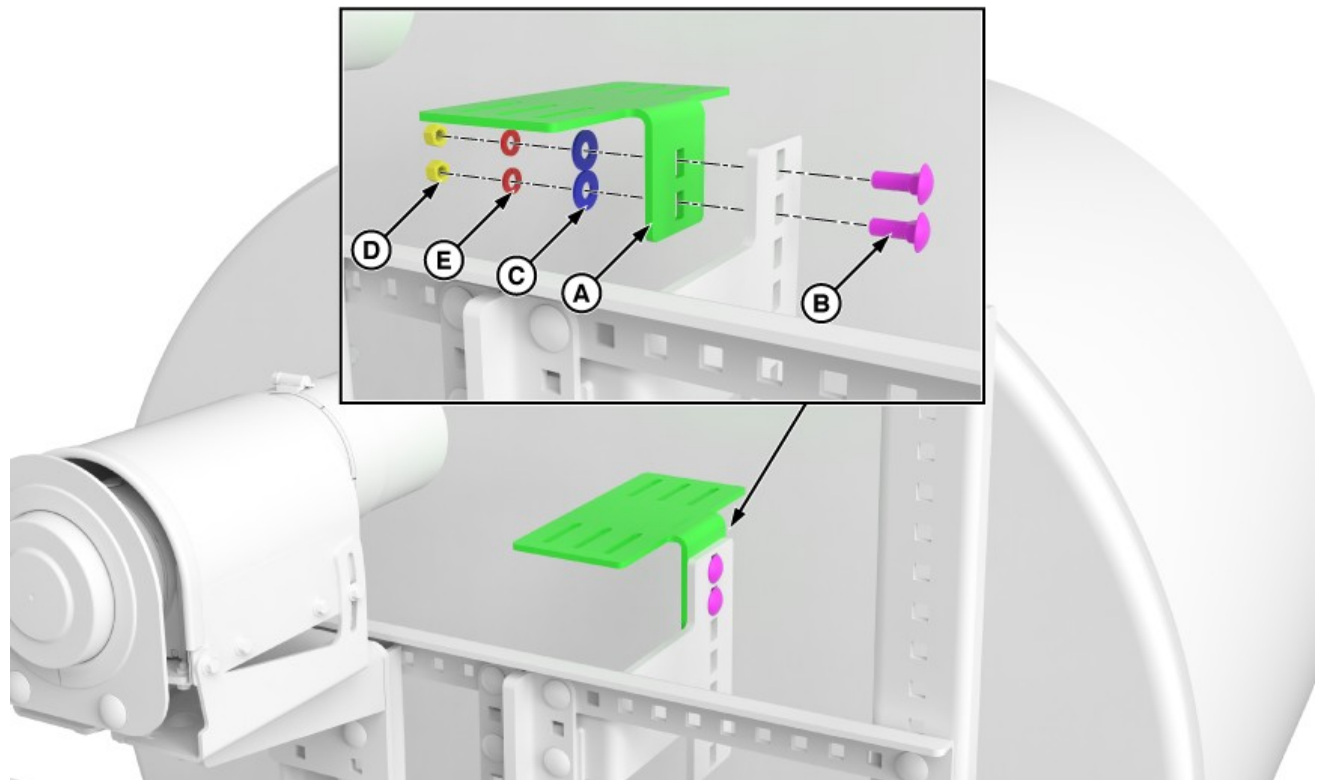

YK133472—UN—12NOV24

Continued on next page

WVFXMED,1730130661570-19-28JAN25-6/10

Step 4 of 5: Blower assembly

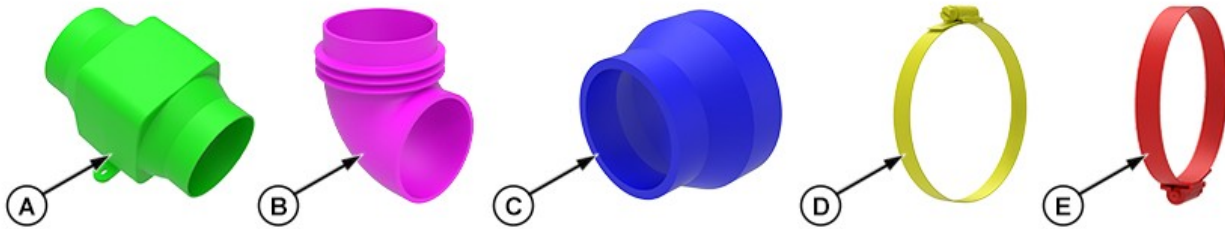

YK130647—UN—25SEP24

Parts required for this step

Identifier	Part Number	Description	Quantity
A	2000138	Blower	1
B	4200326	Elbow	1
C	4200366	Coupler	1
D	7100509	Clamp	3
E	7100504	Clamp	1

1. Ensure that the airflow is directed towards the LiDAR by locating the arrow imprinted on the blower.
2. Assemble flexible elbows (B) and (C) to the blower (A) and secure with clamps (D) and (E) on each connection. Use a 90° angle hook to pull and adjust the flexible elbow if needed.

WVFXMED.1730130661570-19-28JAN25-7/10

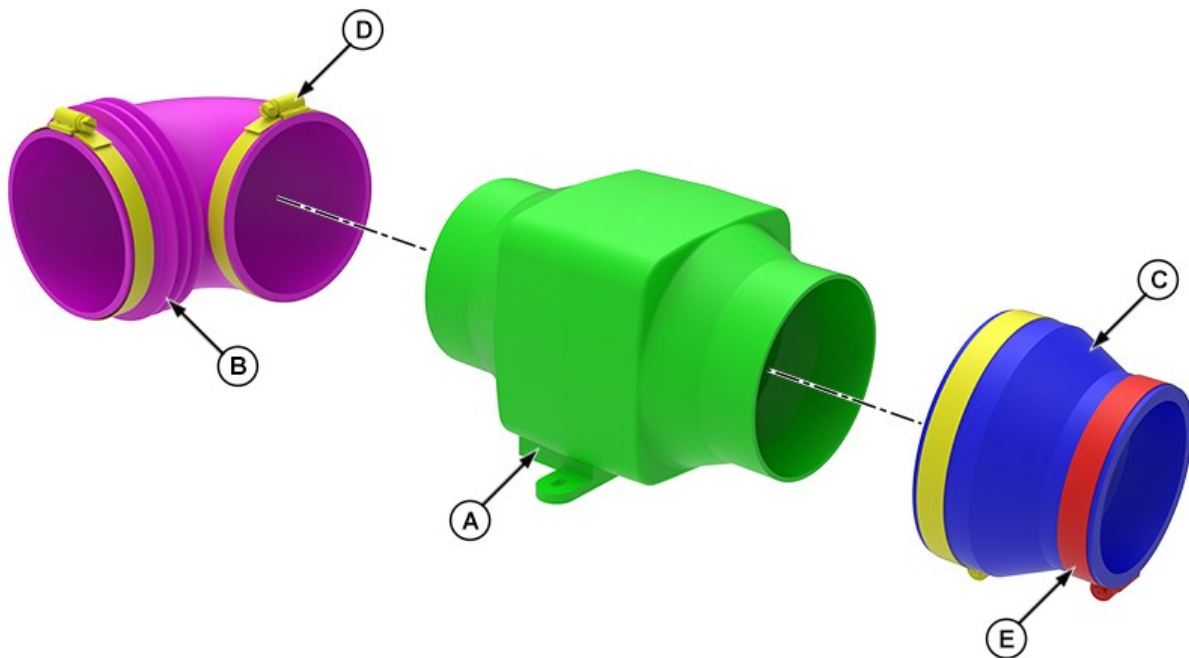

YK130648—UN—25SEP24

Continued on next page

WVFXMED.1730130661570-19-28JAN25-8/10

Step 5 of 5: Blower assembly installation

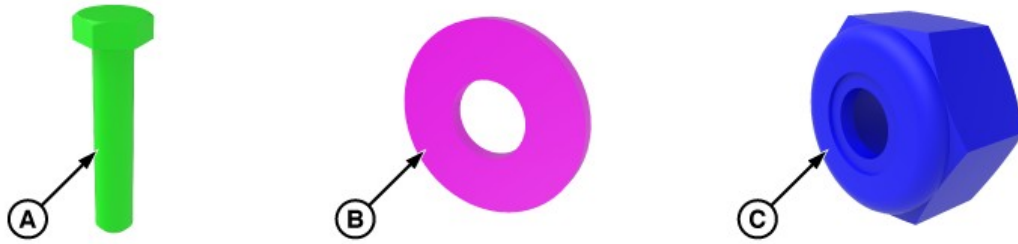

YK133473—UN—12NOV24

Parts required for this step			
Identifier	Part Number	Description	Quantity
A	7100469	Bolt	2
B	7100467	Washer	2
C	7100468	Nut	2

1. Connect blower assembly to LiDAR, then secure it to bracket using bolts (A), washers (B) and nuts (C).

WVFXMED,1730130661570-19-28JAN25-9/10

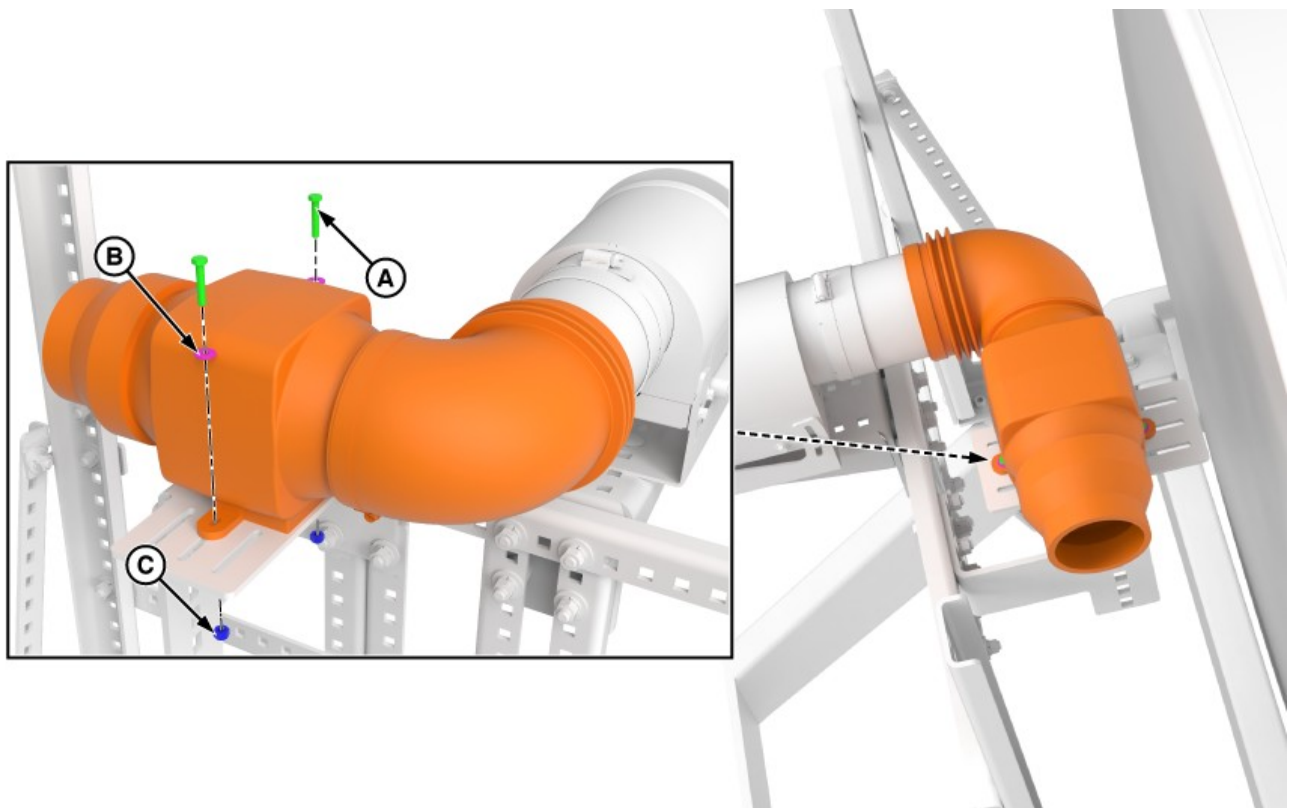

YK133474—UN—12NOV24

WVFXMED,1730130661570-19-28JAN25-10/10

Air Filter Assembly

Step 1 of 4: Air filter base assembly

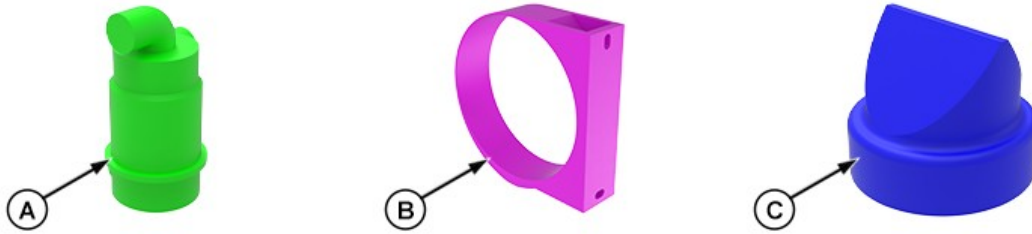

YK130651—UN—25SEP24

Parts required for this step

Identifier	Part Number	Description	Quantity
A	4200351	Air filter	1
B	4200352	Air filter clamp	1
C	4200382	Air filter vacuator	1

1. Assemble air filter (A), air filter clamp (B) and air filter vacuator (C) as shown on image.

WVFXMED,1730130694884-19-07JAN25-1/8

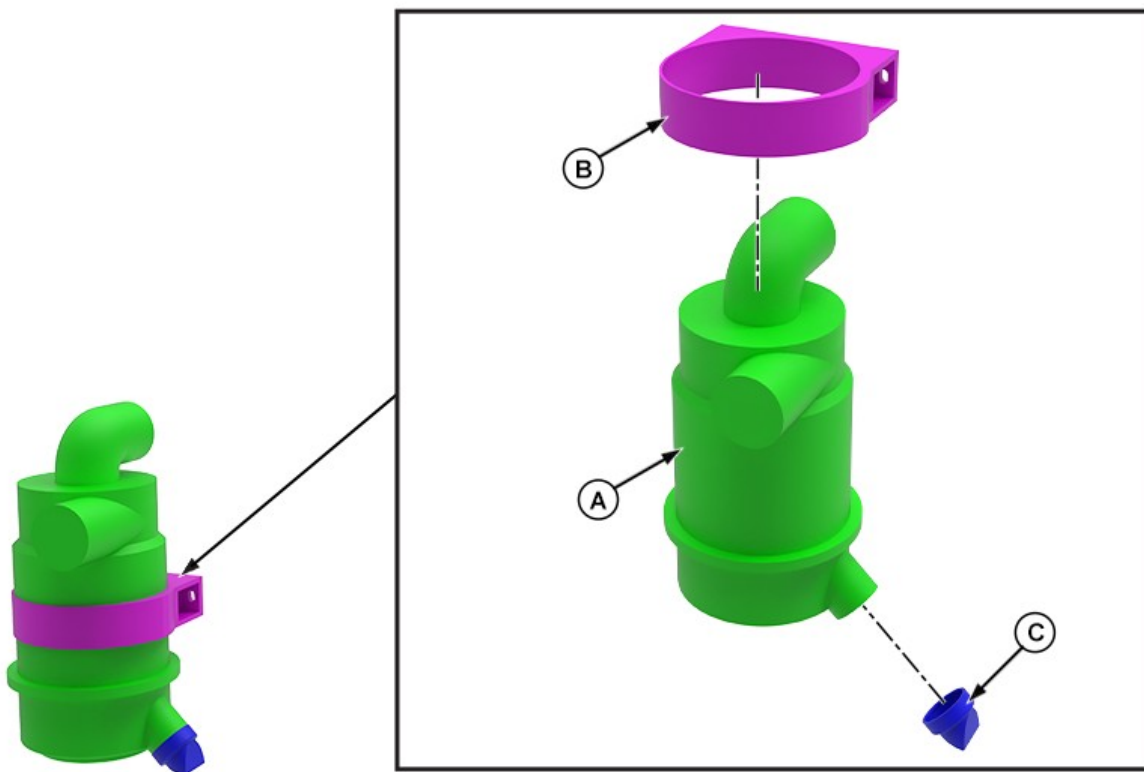

YK130652—UN—25SEP24

Continued on next page

WVFXMED,1730130694884-19-07JAN25-2/8

Step 2 of 4: Bracket installation

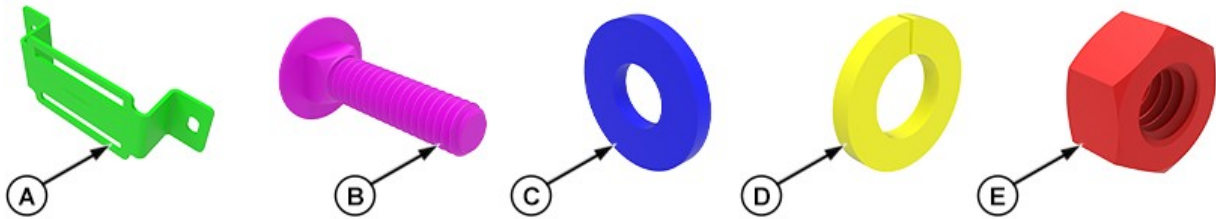

YK130653—UN—25SEP24

Parts required for this step

Identifier	Part Number	Description	Quantity
A	1100303	Bracket	1
B	93180A325	Bolt	2
C	93852A132	Washer	2
D	92147A030	Split washer	2
E	94804A030	Nut	2

1. Install bracket (A) onto the air filter base using bolts (B), washers (C), split washers (D), and nuts (E).

WVFXMED,1730130694884-19-07JAN25-3/8

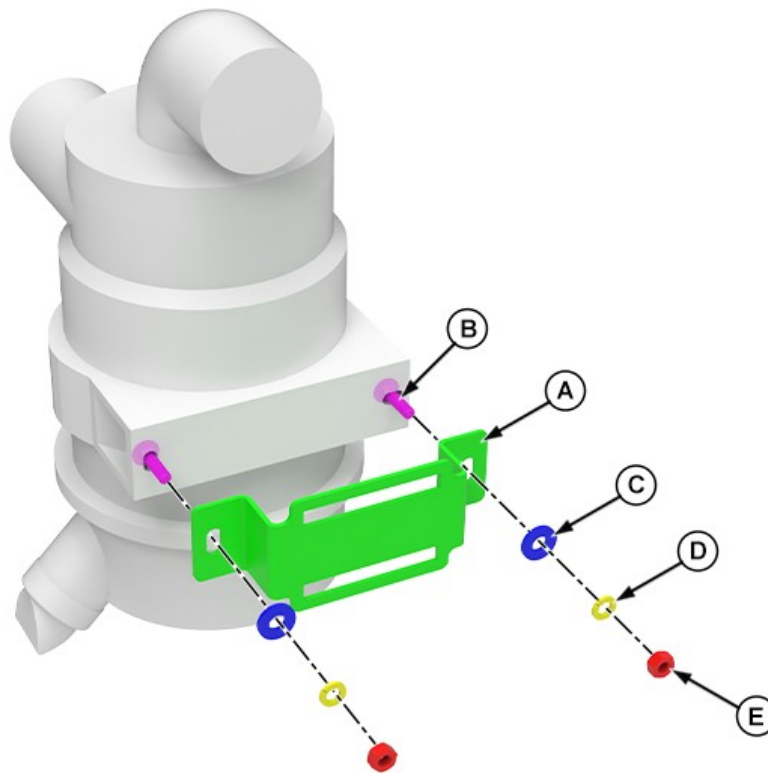

YK130654—UN—25SEP24

Continued on next page

WVFXMED,1730130694884-19-07JAN25-4/8

Step 3 of 4: Elbow installation



YK130655—UN—25SEP24

Parts required for this step

Identifier	Part Number	Description	Quantity
A	4200354	Elbow	1
B	7100504	Clamp	1

1. Install 90° elbow (A) onto the air filter facing down and secure with clamp (B).

WVFXMED,1730130694884-19-07JAN25-5/8

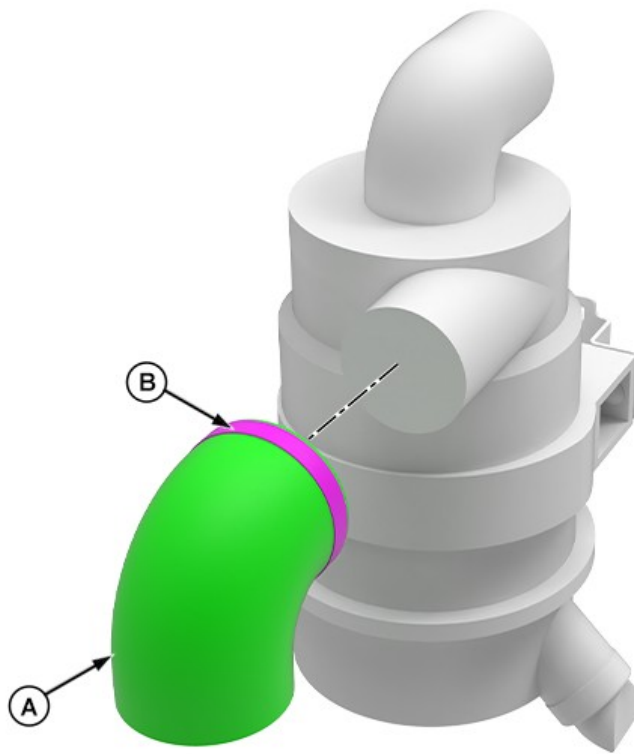

YK130656—UN—25SEP24

Continued on next page

WVFXMED,1730130694884-19-07JAN25-6/8

Step 4 of 4: Air filter base installation

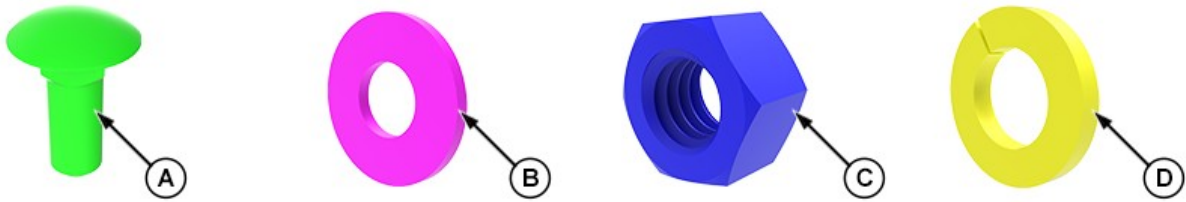

YK133289—UN—22OCT24

Parts required for this step

Identifier	Part Number	Description	Quantity
A	7100462	Bolt	2
B	7100460	Washer	2
C	7100521	Nut	2
D	7100520	Split washer	2

1. Install air filter onto the tower bracket and secure using bolts (A), washers (B), nuts (C), and split washer (D).
2. Connect air filter elbow to LiDAR coupler and secure using the previously installed clamp.
3. Make sure all clamps and hardware previously installed are tightened.

WVFXMED,1730130694884-19-07JAN25-7/8

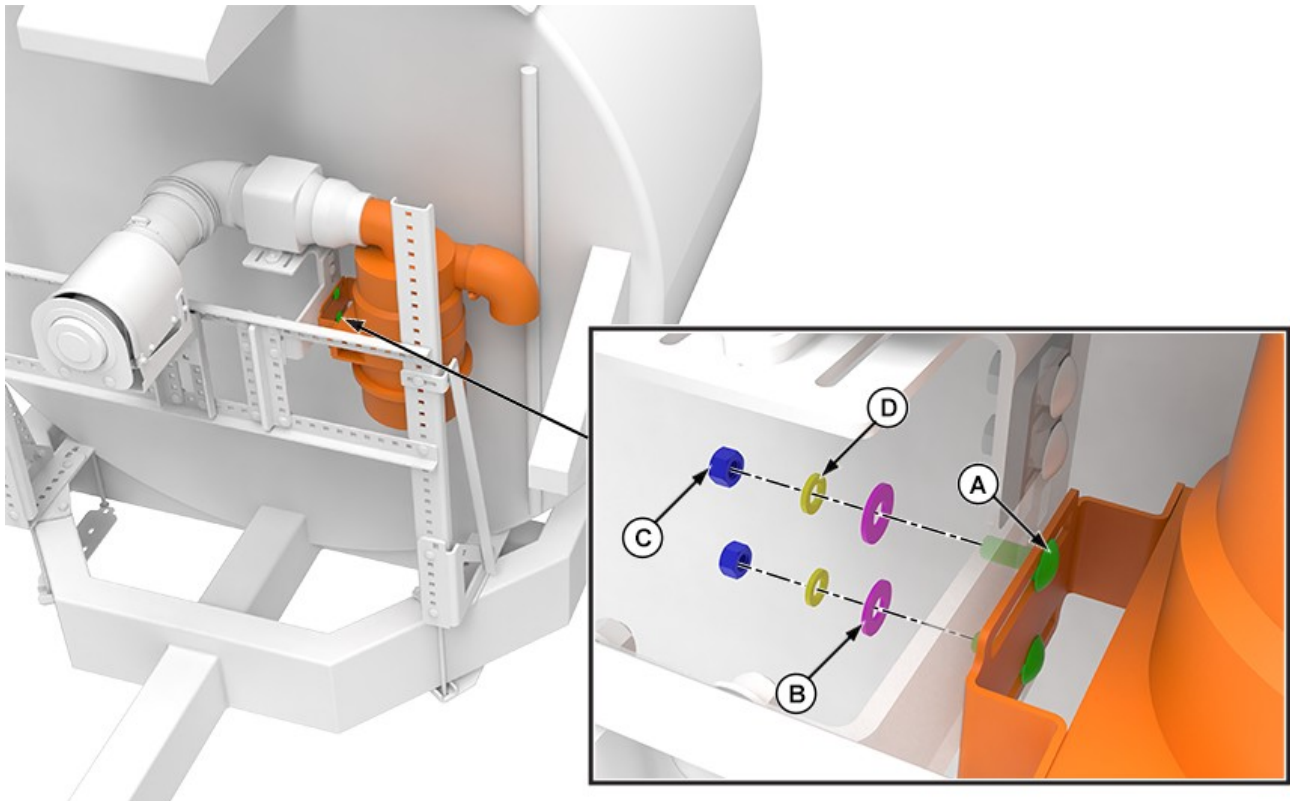

YK133290—UN—22OCT24

WVFXMED,1730130694884-19-07JAN25-8/8

Controller Box Assembly

Step 1 of 4: Brackets disassembly

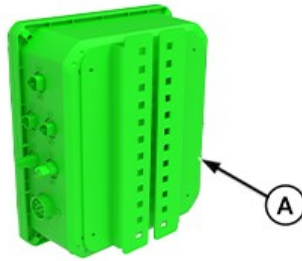

YK130938—UN—15OCT24

Parts required for this step

Identifier	Part Number	Description	Quantity
A	2000165	Controller box	1

1. Loosen the bolts and washers holding the brackets to the controller box (A) and remove the attached brackets.

NOTE: These parts will be reinstalled on a further step.

QD3GM42,1729540846263-19-07JAN25-1/8

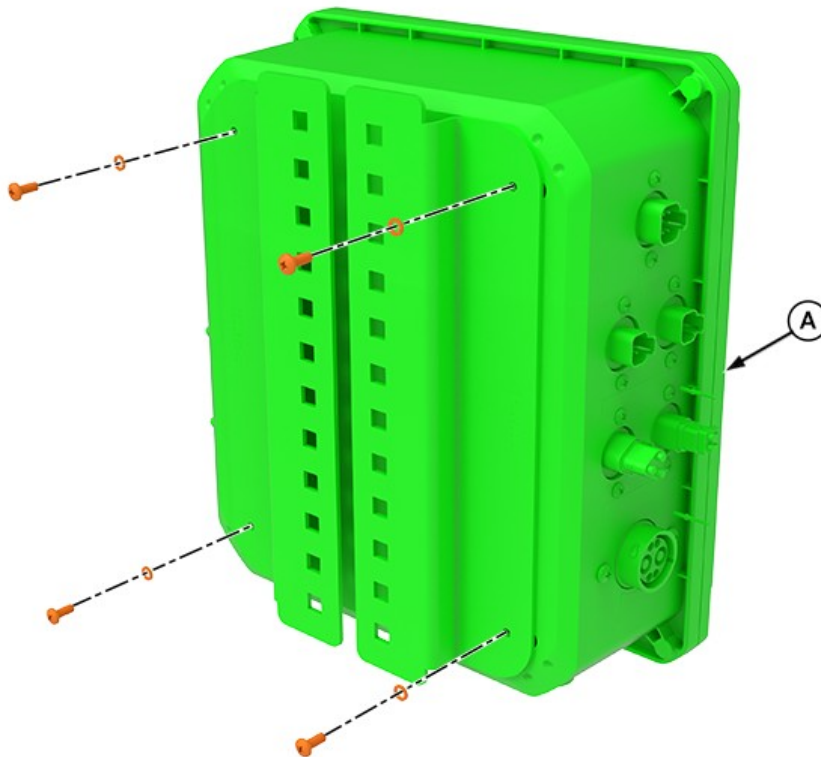

YK130938—UN—15OCT24

Continued on next page

QD3GM42,1729540846263-19-07JAN25-2/8

Step 2 of 4: Control box assembly

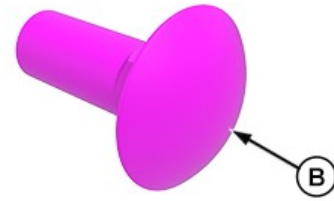
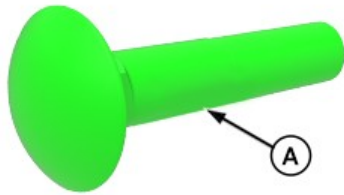

YK130940—UN—15OCT24

Parts required for this step			
Identifier	Part Number	Description	Quantity
A	7100464	Bolt	4
B	7100462	Bolt	2

1. Install bolts (A) and (B) to previously removed bracket on marked locations as shown.
2. Reinstall previously removed bolts and washers to secure brackets to controller box.

QD3GM42,1729540846263-19-07JAN25-3/8

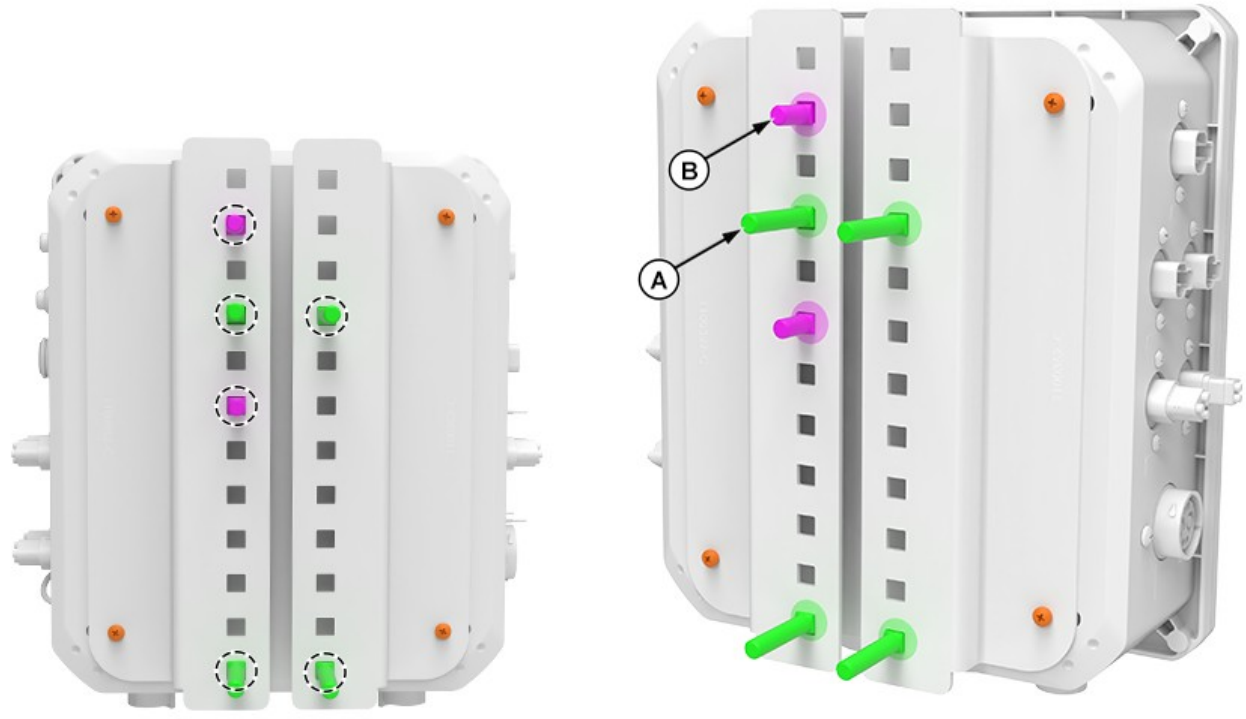

YK130941—UN—15OCT24

Continued on next page

QD3GM42,1729540846263-19-07JAN25-4/8

Step 3 of 4: Bracket installation

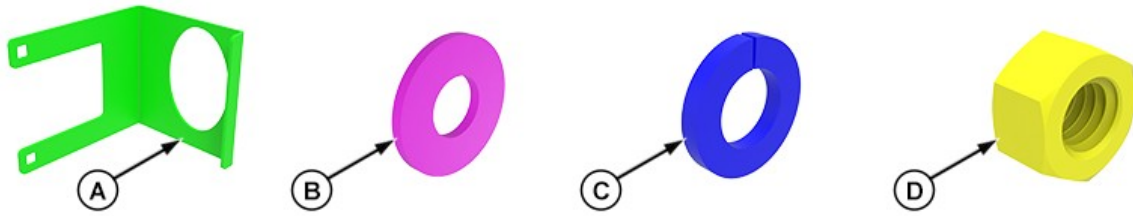

YK129378—UN—29AUG24

Parts required for this step

Identifier	Part Number	Description	Quantity
A	1100384	Bracket	1
B	7100460	Washer	2
C	7100520	Split washer	2
D	7100521	Nut	2

1. Install bracket (A) to control box using washers (B), split washers (C), and nuts (D).

QD3GM42,1729540846263-19-07JAN25-5/8

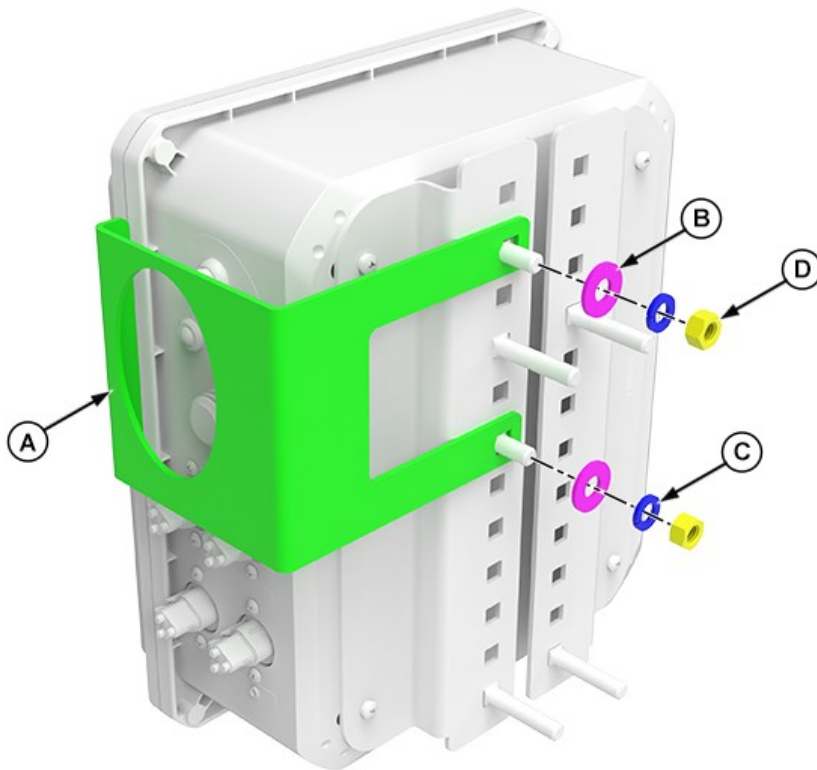

YK130942—UN—15OCT24

Continued on next page

QD3GM42,1729540846263-19-07JAN25-6/8

Step 4 of 4: Control box assembly installation

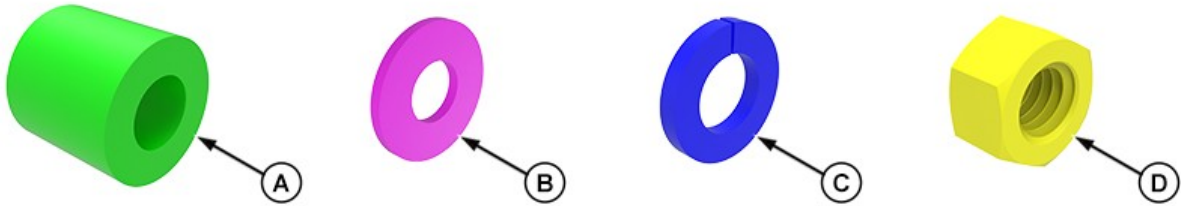

YK130943—UN—15OCT24

Parts required for this step

Identifier	Part Number	Description	Quantity
A	1100267	Spacer	4
B	7100460	Washer	4
C	7100520	Split washer	4
D	7100521	Nut	4

1. Mount controller box assembly onto the bracket using the previously installed bolts and secure using spacers (A), washers (B), split washers (C), and nuts (D).

QD3GM42,1729540846263-19-07JAN25-7/8

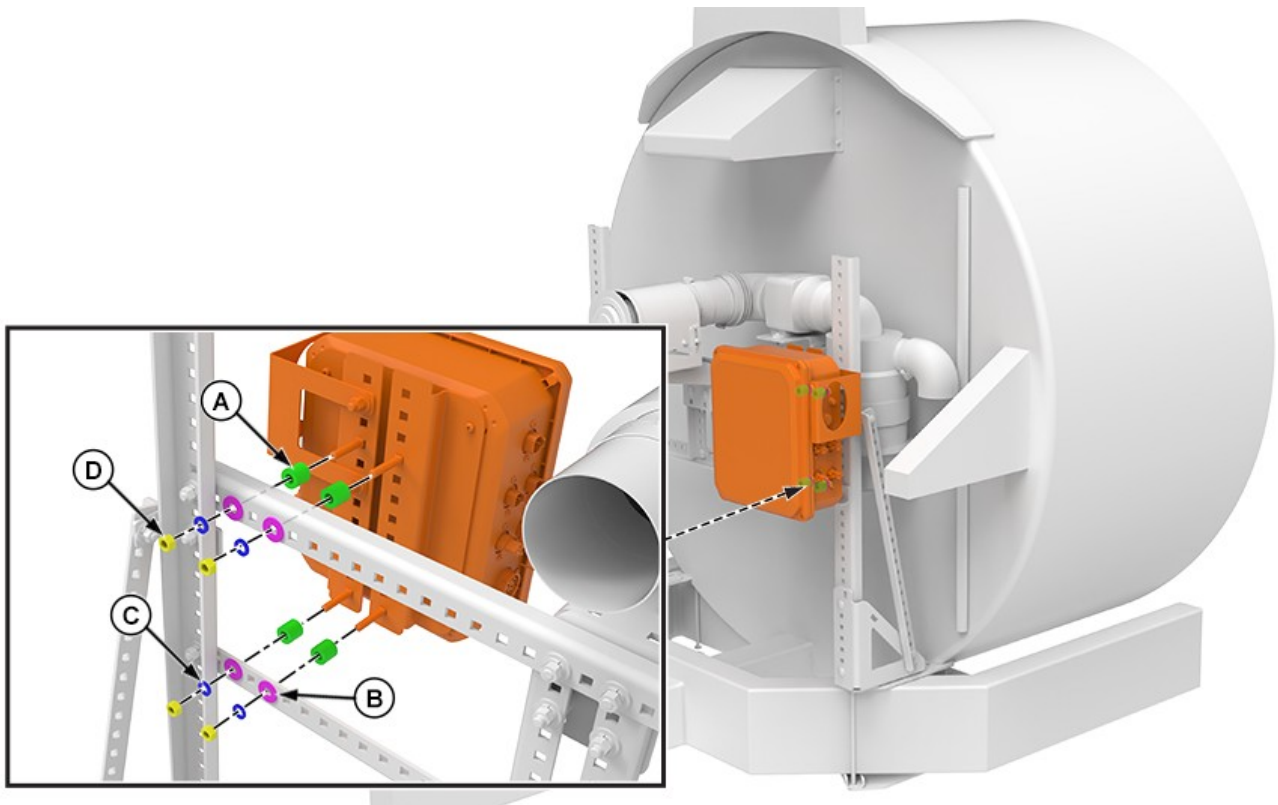

YK130944—UN—15OCT24

QD3GM42,1729540846263-19-07JAN25-8/8

GPS Antenna Assembly

Step 1 of 2: GPS assembly

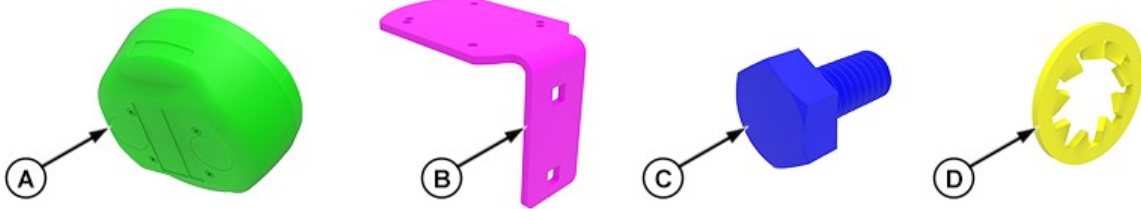

YK129380—UN—29AUG24

Parts required for this step

Identifier	Part Number	Description	Quantity
A	6000132	GPS	1
B	1100263	Bracket	1
C	7100044	Bolt	4
D	7100207	Washer	4

1. Assemble GPS (A) to bracket (B) using bolts (C) and washers (D).

QD3GM42,1729540848768-19-08JAN25-1/4

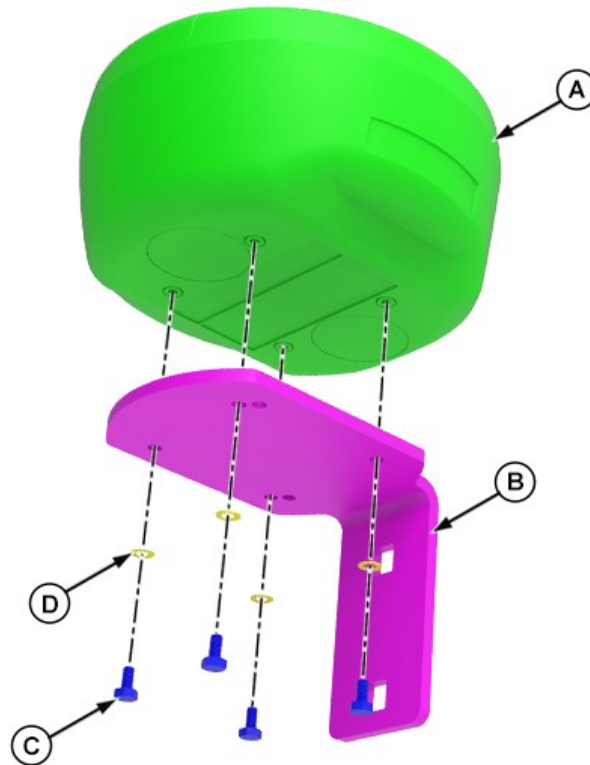

YK129381—UN—29AUG24

Continued on next page

QD3GM42,1729540848768-19-08JAN25-2/4

Step 2 of 2: GPS assembly to machine

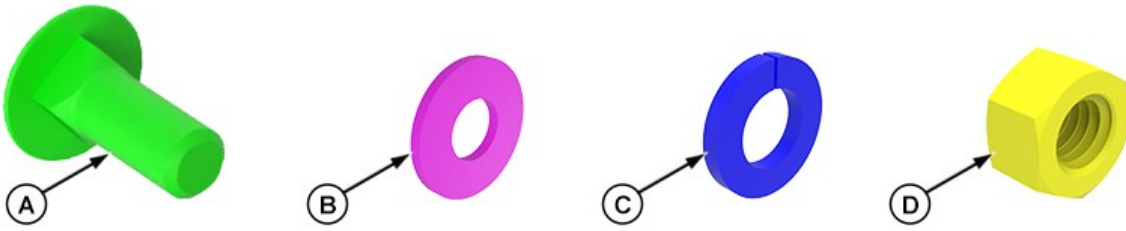

YK129382—UN—29AUG24

Parts required for this step

Identifier	Part Number	Description	Quantity
A	7100462	Bolt	2
B	7100460	Washer	2
C	7100520	Split washer	2
D	7100521	Nut	2

1. Install GPS assembly from previous step to tower bracket using bolts (A), washers (B) and (C), and nuts (D).

QD3GM42, 1729540848768-19-08.JAN25-3/4

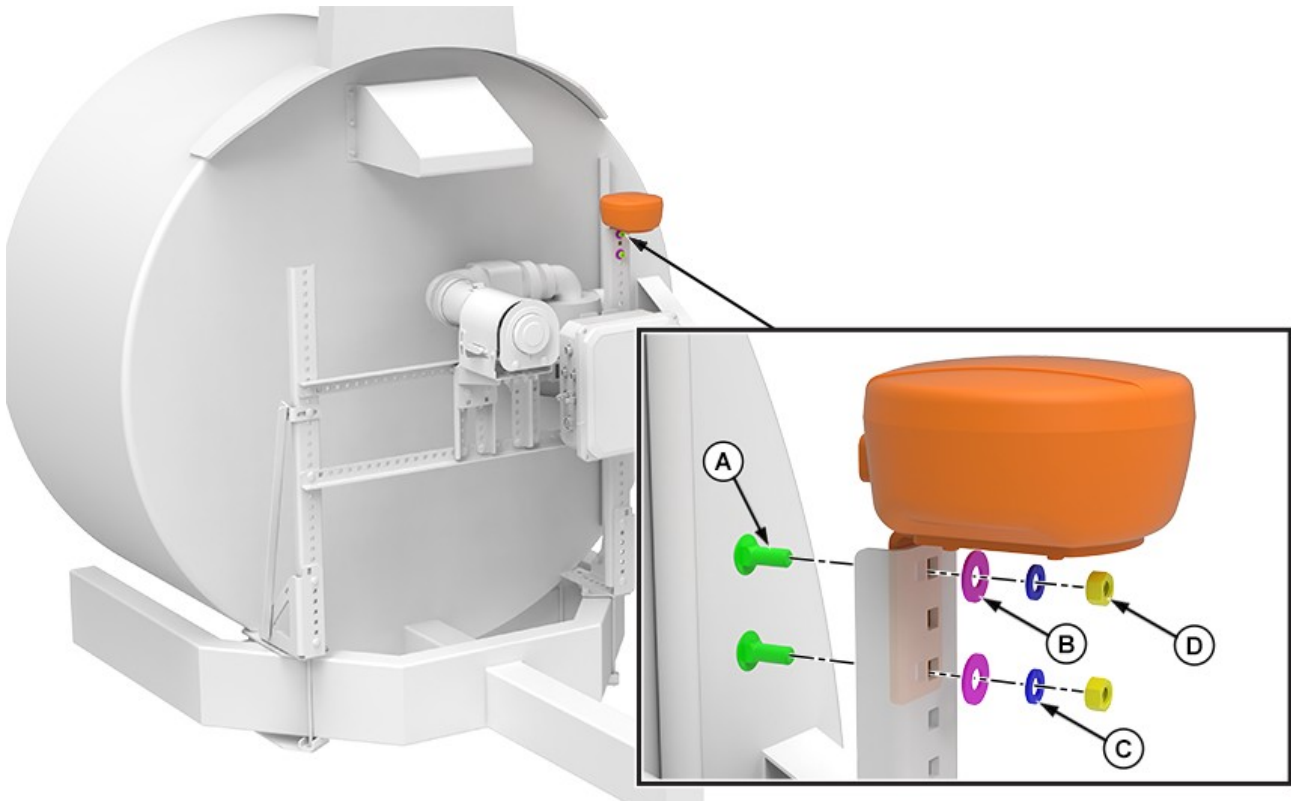

YK130945—UN—15OCT24

QD3GM42, 1729540848768-19-08.JAN25-4/4

Brass Assembly

Step 1 of 2: Brass assembly



YK132884—UN—08NOV24

Parts required for this step		
Identifier	Part Number	Description
A	CP1322	1/4" nipple
B	4200016	Valve
C	4200342	1/4" union

NOTE: Identify the locations of the solenoids as specified by the customer or salesperson in the configuration sheet. Install the brass fittings only in those specific boom sections, while capping off the others (caps not supplied by Smart Apply).

1. Remove all nozzles from the boom using a crescent wrench.
2. Apply Teflon tape to the male threaded section of parts (A) and (B).
3. Connect nipple (A) and union (C) to valve (B) and repeat.

QD3GM42,1730215166817-19-28JAN25-1/4

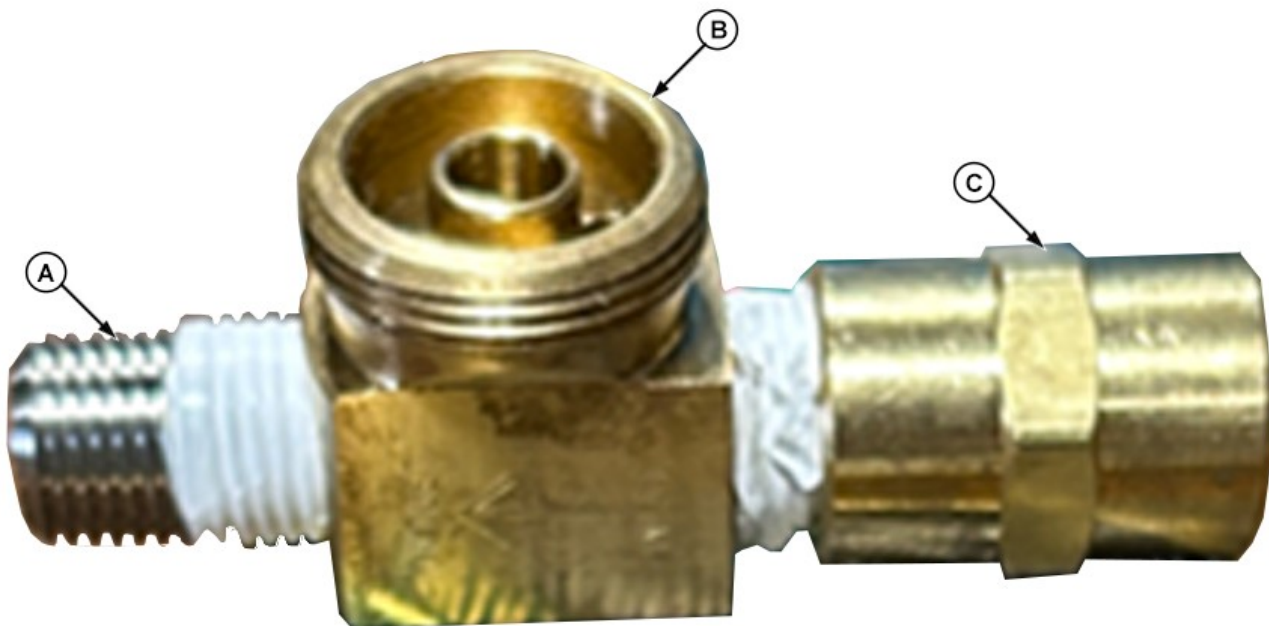

YK132885—UN—08NOV24

Continued on next page

QD3GM42,1730215166817-19-28JAN25-2/4

Step 2 of 2: Brass assembly installation

1. Apply Teflon tape or use sealant paste to your own discretion to the boom male coupler.
2. Install brass assemblies to boom with the valves towards the center.

QD3GM42,1730215166817-19-28JAN25-3/4



YK132886—UN—02DEC24

QD3GM42,1730215166817-19-28JAN25-4/4

Nozzles Assembly

Step 1 of 2: Nozzles and caps installation

1. Install nozzles and caps following the desired sprayer configuration.

QD3GM42,1726149057020-19-17DEC24-1/4

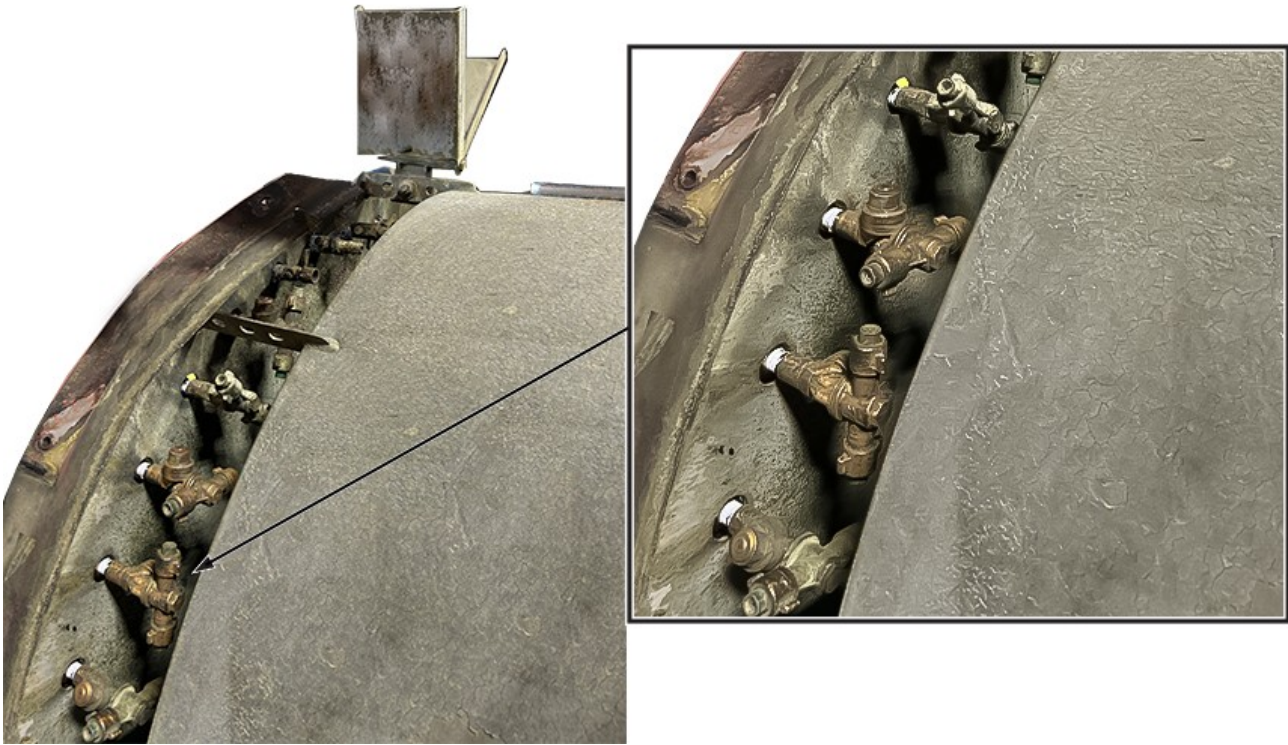

YK129396—UN—08JAN25

Continued on next page

QD3GM42,1726149057020-19-17DEC24-2/4

Step 2 of 2: Check valve installation for inactive nozzles

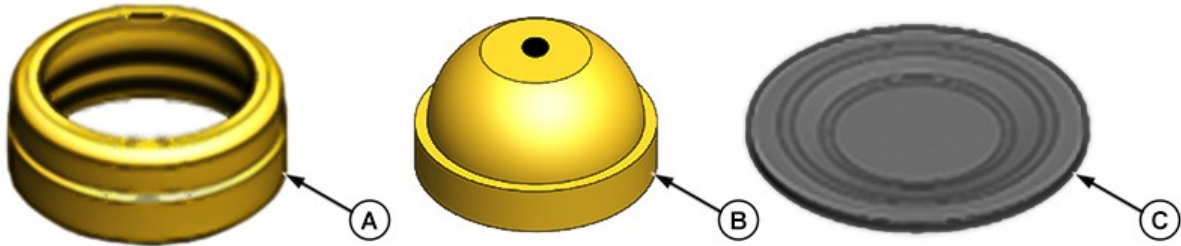

YK129397—UN—08JAN25

Parts required for this step		
Identifier	Part Number	Description
A	CP4624	Threaded ring
B	9758	Check valve
C	CP4620	Gasket

1. Identify the nozzles that are not being used and install threaded ring (A) and check valve (B) with gasket (C) in between.

QD3GM42,1726149057020-19-17DEC24-3/4

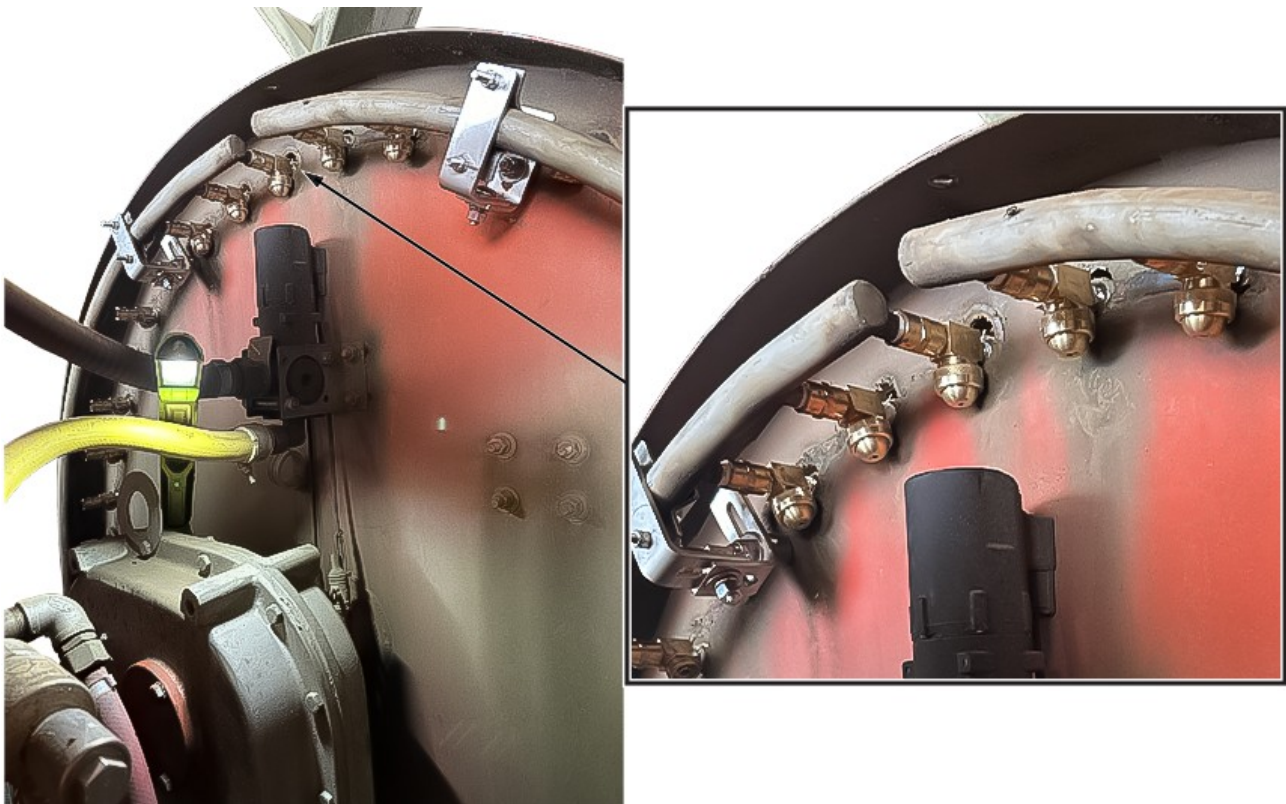

YK134005—UN—12DEC24

QD3GM42,1726149057020-19-17DEC24-4/4

Solenoids Assembly

Step 1 of 2: Solenoid installation



YK130829—UN—02DEC24

Parts required for this step		
Identifier	Part Number	Description
A	4100022	Solenoid
B	1100258	Wrench

1. Identify the installation position of the solenoid (A), ensuring the connector is facing either up or down.

NOTE: Ideally the solenoid will be above the line to ensure it drains effectively by gravity when not in use.

2. If the solenoid is positioned above the line, use wrench (B) to loosen the solenoid tube while holding the nylon nut in place with another wrench.

3. Remove the solenoid body, rotate 180° inside the coil, and install nut.

4. Locate the O-ring on the nylon nut, remove it and install it inside the brass ring.

NOTE: These steps should be followed for all solenoids.

QD3GM42,1730215217720-19-08JAN25-1/4

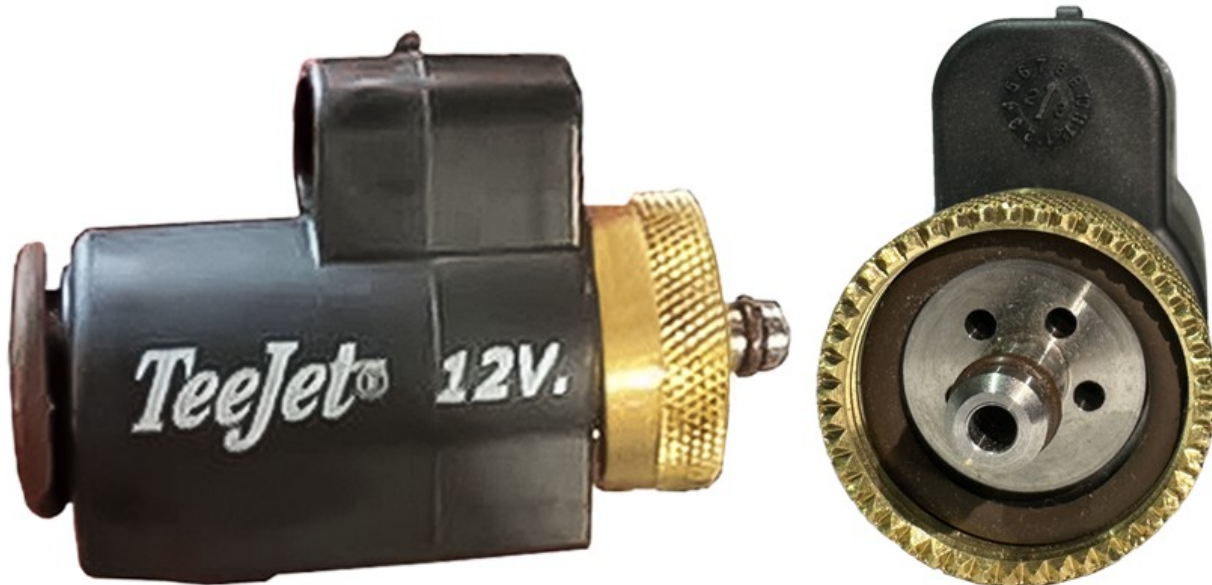

YK130830—UN—08JAN25

Continued on next page

QD3GM42,1730215217720-19-08JAN25-2/4

Step 2 of 2: Solenoids to valve connection

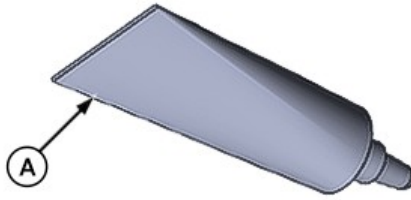

YK130831—UN—02DEC24

Parts required for this step		
Identifier	Part Number	Description
A	7100487	Lubricant

1. Apply lubricant (A) to the outside surface of the small O-ring.
2. Connect the solenoids to the valve, ensuring that the connector is oriented towards the outside of the sprayer.
3. Do final adjustments to the mounting brackets across the boom arms. Make sure that each section is centered.

QD3GM42,1730215217720-19-08JAN25-3/4



YK132887—UN—02DEC24

QD3GM42,1730215217720-19-08JAN25-4/4

Harness Routing

Step 1 of 5: Nozzle potted harness solenoids connection

Parts required for this step			
Identifier	Part Number	Description	Quantity
A	6100130	Nozzle potted harness	2

1. Connect left and right-side nozzle potted harness (A) terminal to the solenoids beginning from the bottom and going upwards.

QD3GM42,1730215236160-19-16JAN25-1/9

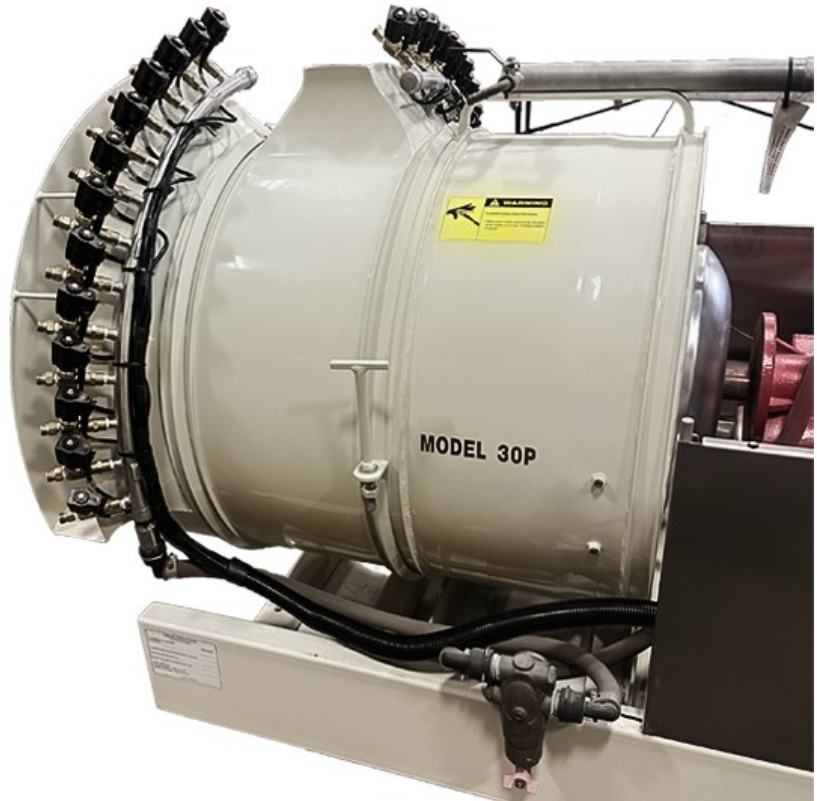

YK132888—UN—02DEC24

Continued on next page

QD3GM42,1730215236160-19-16JAN25-2/9

Step 2 of 5: Nozzle harness extensions routing

Parts required for this step			
Identifier	Part Number	Description	Quantity
A	6100117	Nozzle harness extension	2

1. Route nozzle harness extensions (A) underneath the sprayer compartment, ensuring that the connectors remain on the outside.

NOTE: Make sure there is enough distance from the control box to the rear sprayer compartment.

QD3GM42,1730215236160-19-16JAN25-3/9

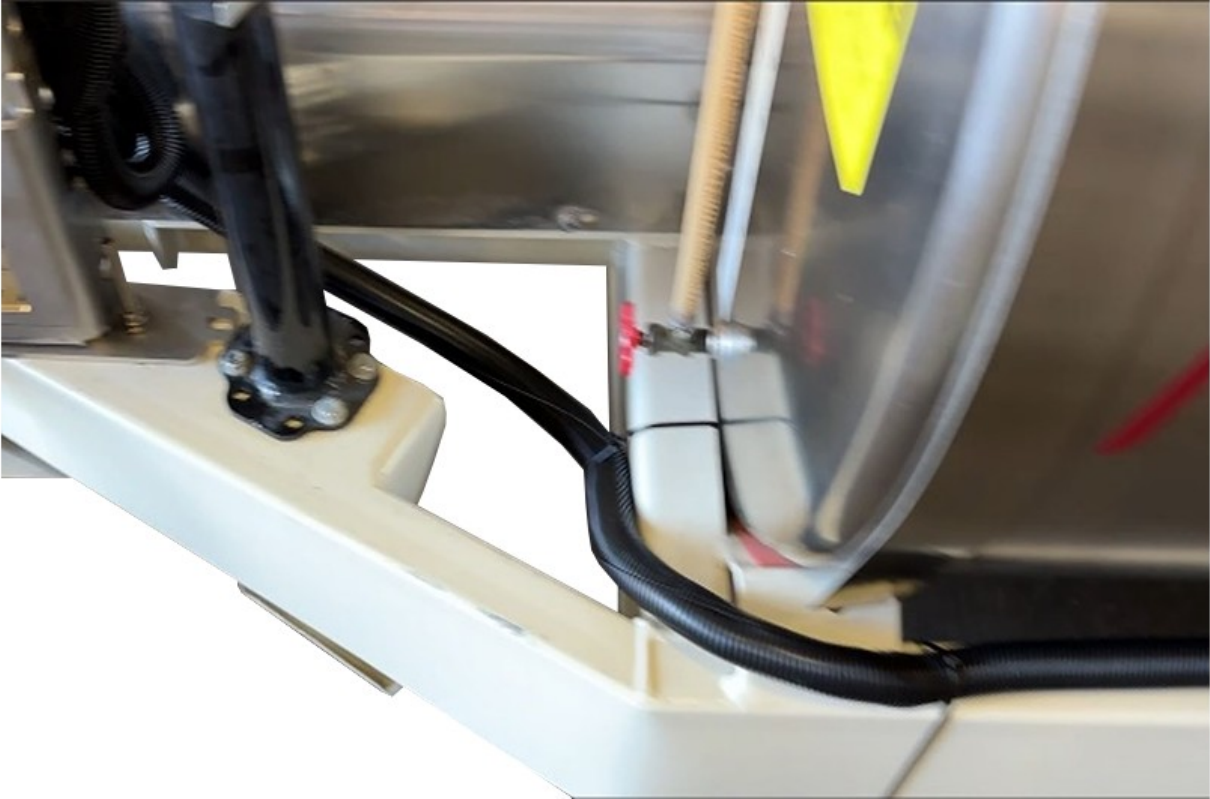

YK132889—UN—07NOV24

Continued on next page

QD3GM42,1730215236160-19-16JAN25-4/9

Step 3 of 5: Harness extensions connections

1. Connect harness extensions to the nozzle potted harness.
2. Connect harness extension to controller box.

QD3GM42,1730215236160-19-16JAN25-5/9



Continued on next page

QD3GM42,1730215236160-19-16JAN25-6/9

YK132890—UN—07NOV24

Step 4 of 5: Battery harness connections

Parts required for this step			
Identifier	Part Number	Description	Quantity
A	6100111	Battery harness	1
B	6100185	Battery harness extension	1

1. Connect battery harness (A) to the battery inside the sprayer. Use harness extension (B) when connecting to the tractor's battery.
2. Route the harness from the battery to the control box, ensuring it avoids any moving parts. Follow the existing path of the tractor harnesses to the battery for proper installation.

QD3GM42,1730215236160-19-16JAN25-7/9



YK132891—UN—07NOV24

Continued on next page

QD3GM42,1730215236160-19-16JAN25-8/9

Step 5 of 5: Wiring harnesses connections

Parts required for this step			
Identifier	Part Number	Description	Quantity
A	6100110	Antenna harness	1
B	6100134	Antenna harness extension	1
C	6100123	LiDAR harness	1
D	6100127	Power extension harness	1

1. Connect one plug of harness extension (A) to the GPS antenna and the other plug to the controller box. Use harness extension (B) if necessary.
2. Connect one plug of harness extension (C) to the LiDAR harness and the other plug to the controller box.
3. Connect one plug of harness (D) to the blower/fan harness and the other plug to the controller box.

QD3GM42,1730215236160-19-16JAN25-9/9

Electrical Diagram

Refer to the diagram below to identify the correct connections for each harness to the control box.

HL70592,1737150340827-19-27JAN25-1/2

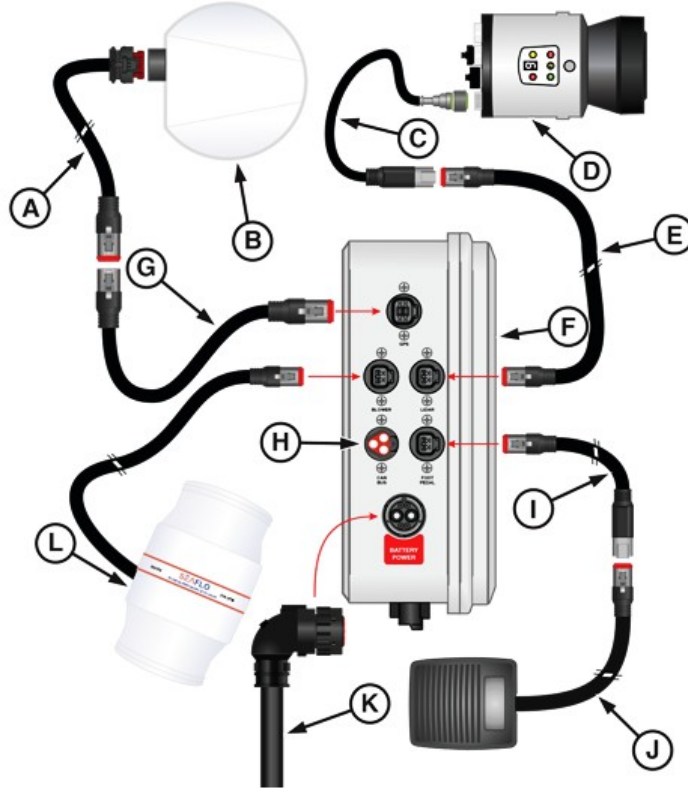

YK135244—UN—23JAN25

Parts required for this step

Identifier	Part Number	Description	Identifier	Part Number	Description
A	6100110	GPS antenna harness	G	6100134	GPS extension harness
B	6000132	GPS antenna	H	-	CAN BUS is to connect a second controller
C	6100126	LiDAR power harness	I	6100132	Foot pedal extension
D	6000047	LiDAR	J	6100075	Foot pedal switch
E	6100123	LiDAR power extension	K	6100185	Battery extension
F	2000165	Gen 2 control enclosure	L	2000138	LiDAR blower

HL70592,1737150340827-19-27JAN25-2/2

Liquid Filter Kit

NOTE: It is recommended to have two stages of filtration in the system. If there is already a filter on the boom, you may not need to install the additional filter shown in this section.

Step 1 of 1: Strainer installation

Parts required for this step			
Identifier	Part Number	Description	Quantity
A	4200195	Strainer	1
B	4200188	Hose barb to 3/4 inch	2
C	4200194	Hose barb to 1 inch	2
D	7100348	Clamp	2

1. Locate the boom lines and cut a section of hose to fit strainer (A).
2. Install one end of hose barb (B) or (C) on each side of the strainer (A), and connect the other end of the hose barb to the previously cut boom lines.
2. Secure the connection between the strainer and the boom line using clamps (D).

NOTE: Choose the appropriate hose barb (B) or (C) from list according to the hose size.

QD3GM42,1726149146911-19-24JAN25-1/2



YK130834—UN—08JAN25

QD3GM42,1726149146911-19-24JAN25-2/2

Pressure Regulator Kit

Step 1 of 7: Boom supply and return line location

1. Locate boom supply and return to tank lines.

QD3GM42,1730215304017-19-08JAN25-1/13

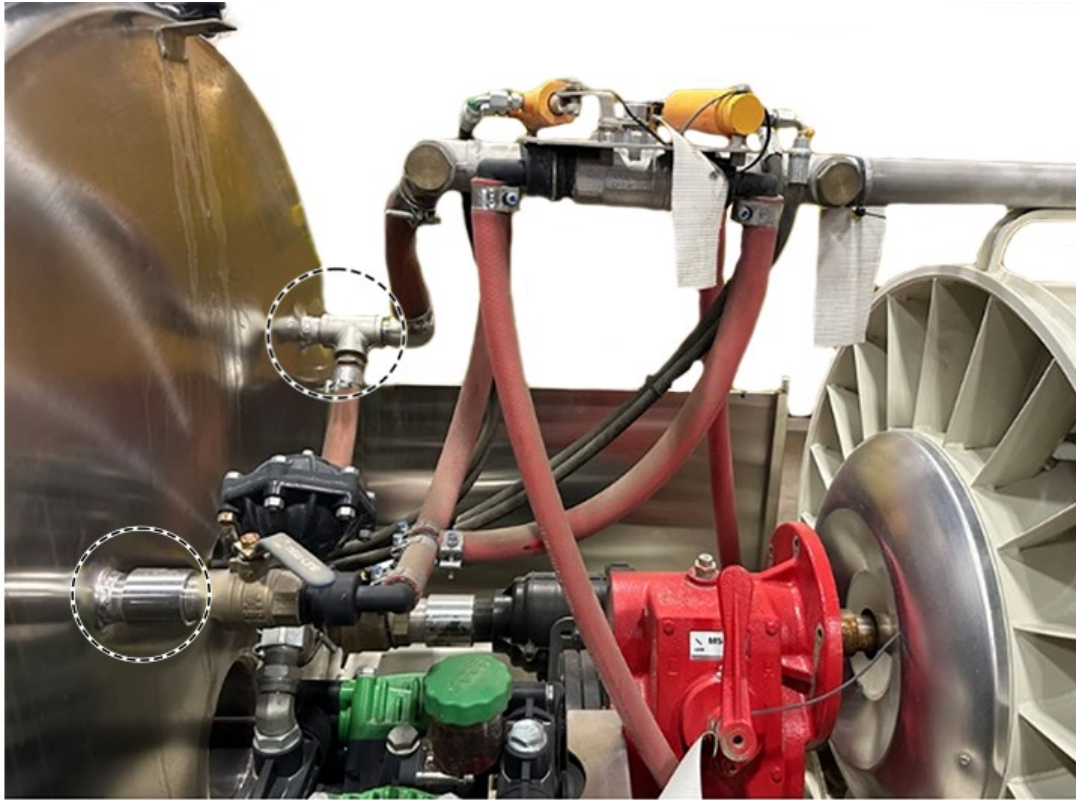

YK132892—UN—07NOV24

Continued on next page

QD3GM42,1730215304017-19-08JAN25-2/13

Step 2 of 7: Hose disengagement

1. Disengage the hose from the barb to disassemble 90° elbow from the relief nipple.

QD3GM42,1730215304017-19-08JAN25-3/13

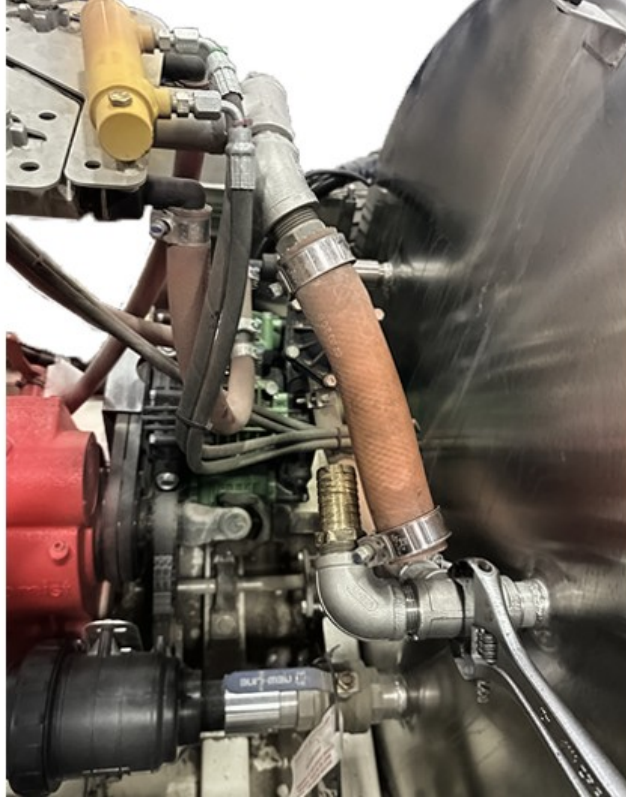

YK133945—UN—02DEC24

Continued on next page

QD3GM42,1730215304017-19-08JAN25-4/13

Step 3 of 7: Pressure regulator installation

Identifier	Part Number	Description
A	4200384	3/4" nipple
B	4200371	1" nipple
C	4200372	1" tee valve
D	4200368	1" ball valve
E	AA110-1	1" pressure regulator
F	4200370	1" hose barb

1. Install 1 nipple (A), 1 nipple (B), 1 tee valve (C), 1 ball valve (D), and 1 pressure regulator (E) to the relief side. Apply Teflon tape or thread sealant between all connections.
2. Install 1 hose barb (F) onto the pressure regulator valve and the original sprayer hose barb onto the tee. Apply Teflon tape or thread sealant between all connections.

QD3GM42,1730215304017-19-08JAN25-5/13



Continued on next page

QD3GM42,1730215304017-19-08JAN25-6/13

YK133946—UN—02DEC24

Vertical Tower Assembly That Attaches to the Sprayer Structural Frame

Step 4 of 7: Return to tank lines

Identifier	Part Number	Description
A	4200371	1" nipple
B	4200372	1" tee valve

1. Disconnect the ball valve from the return to tank nipple.
2. Install 1 tee (B) and 1 nipple (A). Apply Teflon tape or thread sealant between all connections.

Continued on next page

QD3GM42,1730215304017-19-08JAN25-7/13

Step 5 of 7: Ball valve reinstallation

Identifier	Part Number	Description
A	4200370	1" hose barb
B	4200369	1" 90° elbow

1. Install 1 elbow (B) onto the tee valve and attach 1 hose barb (A) to the other end of the elbow.
2. Reinstall the ball valve onto the return to tank nipple.

QD3GM42,1730215304017-19-08JAN25-8/13

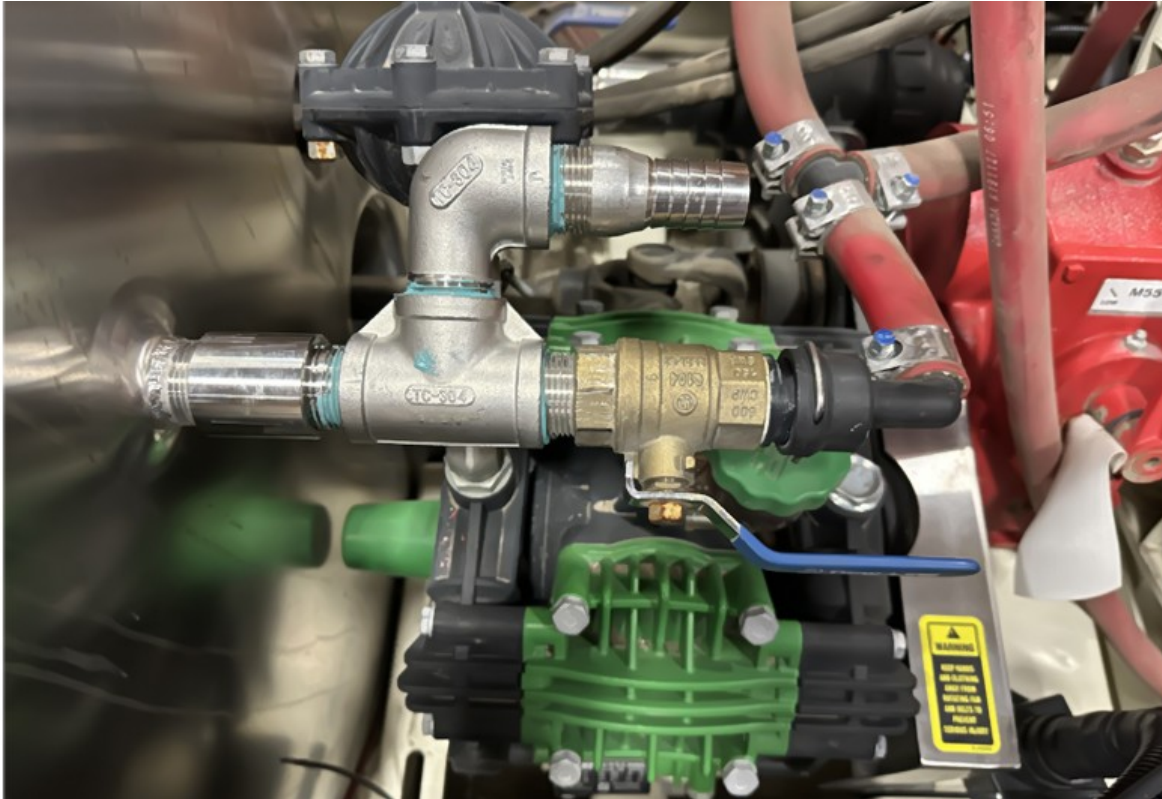

YK133947—UN—02DEC24

Continued on next page

QD3GM42,1730215304017-19-08JAN25-9/13

Step 6 of 7: Hose installation

Identifier	Part Number	Description
A	4200229	1" hose
B	7100348	Clamp

1. Position hose (A) above the hose barbs and cut it to the required length.
2. Install one end of hose to the hose barb installed and secure using 2 clamps (B).

QD3GM42,1730215304017-19-08JAN25-10/13



YK133948—UN—02DEC24

Continued on next page

QD3GM42,1730215304017-19-08JAN25-11/13

Step 7 of 7: Hose installation

Identifier	Part Number	Description
A	4200229	1" hose
B	7100348	Clamp

1. Repeat step 6 to the other end of the hose to establish connection between the relief and return to tank.

NOTE: Additional fittings are included in the kit to ensure the best possible connection, depending on the valve's location and the available space under the hood of your sprayer.

QD3GM42,1730215304017-19-08JAN25-12/13

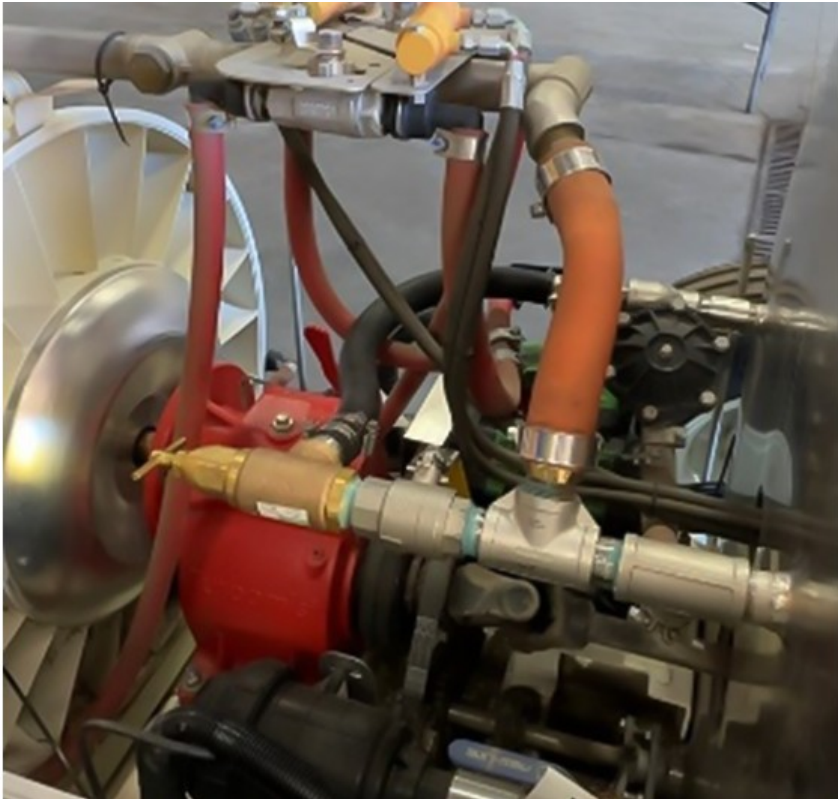

YK133949—UN—02DEC24

QD3GM42,1730215304017-19-08JAN25-13/13

